

ILLUM WIKKELSØ

1

FACTS:

The chair was made by:
Michael Laursen in 1959.
Model 103



Made in Rosewood, teak and oak.

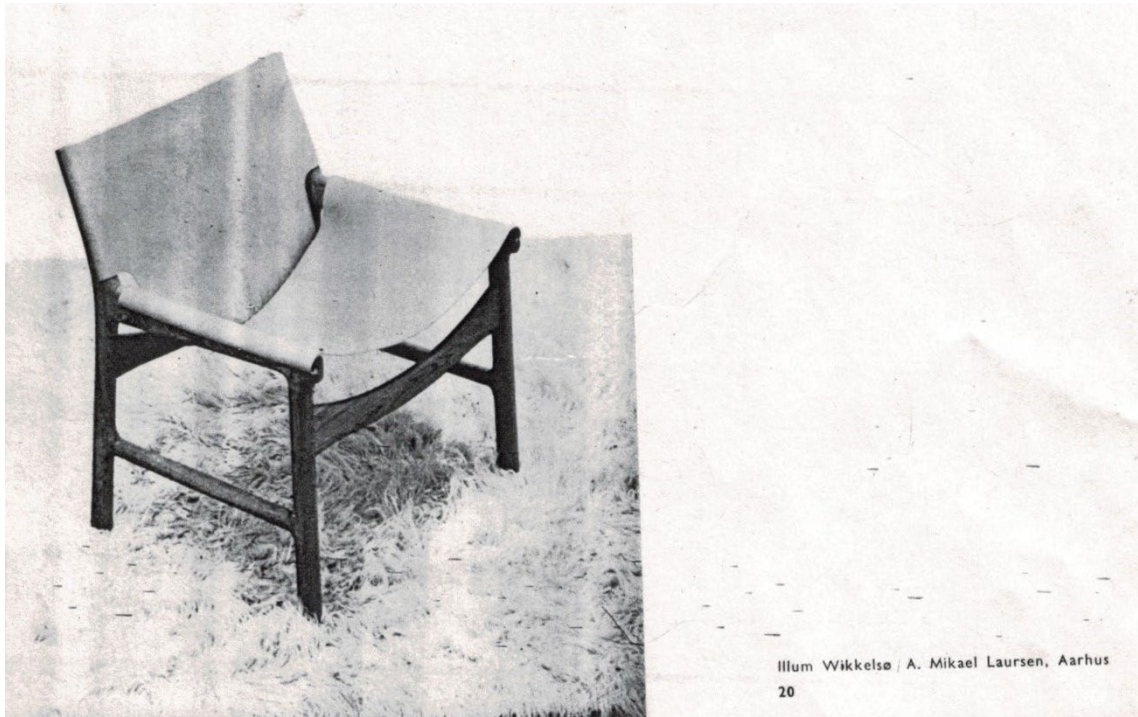

Illum Wikkelsø / A. Mikael Laursen, Aarhus
20

ILLUM WIKKELSØ

2

FACTS:

The chair was made by:
C. F. Christensen 1972.
Easy chair.
Model: Venus



Foto:
Illum Wikkelsø
sitting in the chair



VENUS, modular system. Poly-down cushions. Types of wood: teak, natural oak, fumed oak in bog-oak shade, and rosewood. The Venus-range includes: easy-chair, sofas and tables.

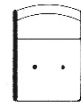

901
stol uden arme
træ massivt
puder polydun
på gummigjorde

chair no arms
wood solid
cushions polydowns
on rubber straps

Sessel ohne Armlehnen
Holz massiv
Kissen Polydaunen
auf Gummigurten

63 x 73 cm H: 79 cm
25" x 29" H: 31"

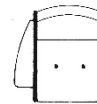

902
stol med 1 arm
træ massivt
puder polydun
på gummigjorde

chair with 1 arm
wood solid
cushions polydowns
on rubber straps

Sessel mit 1 Armlehne
Holz massiv
Kissen Polydaunen
auf Gummigurten

81 x 73 cm H: 79 cm
32" x 29" H: 31"

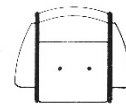

903
stol med 2 arme
træ massivt
puder polydun
på gummigjorde

chair with 2 arms
wood solid
cushions polydowns
on rubber straps

Sessel mit 2 Armlehnen
Holz massiv
Kissen Polydaunen
auf Gummigurten

99 x 73 cm H: 79 cm
39" x 29" H: 31"



ILLUM WIKKELSØ

2.A

FACTS:

Table model Venus
Made by
C. F. Christensen



VENUSBORDE nr. 911, 913. Leveres i teak, palisander, lys eg og røget eg i farven moseeg. Spec. se bagsiden.

VENUS-TISCHE Nr. 911, 913. Lieferbar in Teak, Palisander, Eiche natur und Raucheiche in der Farbe mooreiche. Nähere Angaben vergl. Rückseite.

VENUS-TABLES Nos. 911, 913. Available in teak, rosewood, natural oak and fumed oak in bog-oak shade. See specifications on back.

TABLES VENUS no. 911, 913. Teck, palissandre, chêne nature et chêne fumé ton chêne de marais. Spécifications: voir au verso.

ILLUM WIKKELSØ

2.B

FACTS:

Glass-Table model Venus
Made by
C. F. Christensen



GLASBORD nr. 912. Leveres i teak, palisander, lys eg og røget eg i farven moseeg. Diameter 105 cm, højde 42 cm.

GLASTISCH Nr. 912. Lieferbar in Teak, Palisander, Eiche natur und Raucheiche, in der Farbe mooreiche. Durchmesser 105 cm, Höhe 42 cm.

GLASS-TABLE No. 912. Available in teak, rosewood, natural oak and fumed oak in bog-oak shade. Diameter 41½", height 16½".

TABLE DESSUS EN VERRE no. 912. Teck, palissandre, chêne nature et chêne fumé ton chêne de marais. Diam. 105 cm, hauteur 42 cm.

ILLUM WIKKELSØ

2.C

FACTS:

Lounge chair
Model Sirius
Made by
C. F. Christensen



Sirius table series see next page

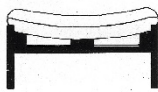

200
taburet, adskillelig
træ massivt
pude polyether-spaghetti
på ravndug

stool KD
wood solid
cushion
polyether-spaghetti
on duck

Hocker, zerlegbar
Holz massiv
Kissen
Polyether-spaghetti
auf Raben-tuch

80 x 55 cm H: 35 cm
32" x 22" H: 14"

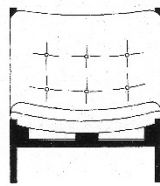

203
stol, adskillelig
træ massivt
puder
polyether-spaghetti
på ravndug

chair KD
wood solid
cushions
polyether-spaghetti
on duck

Sessel, zerlegbar
Holz massiv
Kissen
Polyether-spaghetti
auf Raben-tuch

80 x 76 cm H: 93 cm
32" x 30" H: 37"

SIRIUS – stol og taburet i bejdet pitch-pine m/læder.

SIRIUS – easy-chair and stool in stained pitch-pine covered in leather.

SIRIUS – Sessel und Hocker in Pitch-pine gebeizt mit Leder.

ILLUM WIKKELSØ

2.D

FACTS:

Table
Model Sirius
Made by
C. F. Christensen

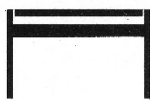

211
sofabord, adskilleligt
plade og underdel
massiv

coffee-table KD
top and base solid

Sofatisch, zerlegbar
Platte und Gestell
massiv

150 x 81 cm H: 50 cm
59" x 32" H: 20"

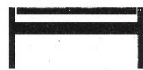

212
hjørnebord, adskilleligt
plade og underdel
massiv

corner-table KD
top and base solid

Ecktisch, zerlegbar
Platte und Gestell
massiv

76 x 76 cm H: 35 cm
30" x 30" H: 14"



213
sidebord, adskilleligt
plade og underdel
massiv

side-table KD
top and base solid

Seitentisch, zerlegbar
Platte und Gestell
massiv

50 x 76 cm H: 35 cm
20" x 30" H: 14"

SIRIUS – hjørne-, side- og sofabord
leveres i lys og mørk bejdset massiv
pitch-pine.

SIRIUS – corner-, side- and coffee table
available in natural or dark stained so-
lid pitch-pine.

SIRIUS – Eck-, Seiten- und Sofatisch
in Pitch-pine massiv hell oder dunkel-
gebeizt.

ILLUM WIKKELSØ

3

FACTS:

Easy chair.
Made by:
Mikael Laursen
1972.

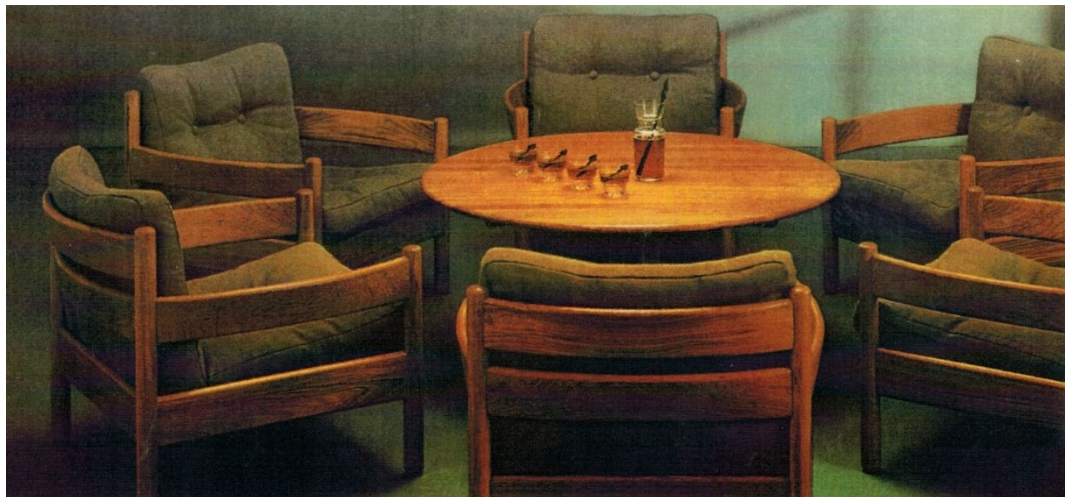

ILLUM WIKKELSØ

4

Easy chair,
Model 20.
Made by
N. Eilersen 1966.



Dimensions

H: 27.56 in. W: 29.53 in. D: 29.53 in. H: 70 cm W: 75 cm D: 75 cm
Seat height 15.75 in. (40 cm)

Also available as sofa.

Dimensions

H: 30.5 in. W: 78 in. D: 29 in. H: 77.47 cm W: 198.12 cm D: 73.66 cm
Seat height 16.5 in. (41.91 cm)



ILLUM WIKKELSØ

4A

High back
lounge chair
Model 20
Made by
N. Eilersen



Dimensions high back lounge chair

H: 37.01 in. W: 29.14 in. D 33.86 in.
Seat height 16.54 in. (42 cm)

H: 94 cm W: 74 cm D: 86 cm

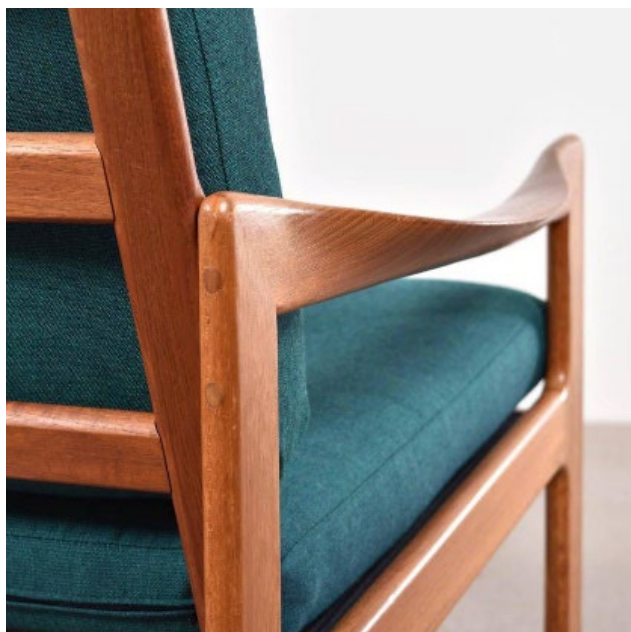

ILLUM WIKKELSØ

4B

Sofa Model 20
Made by
N. Eilersen



Juhls Bolighus - Sønderborg - Danmark

3-68

Gruppe i læder eller stof
Polydunpuder
Eg - teak

Group in leather or fabric
Polydown-cushions
Oak - teak

Gruppe in Leder oder Stoff
Poly-Downkissen
Eiche - Teak

Design: Illum Wikkelsø

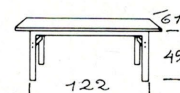
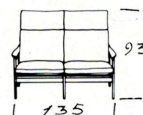
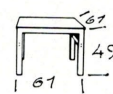
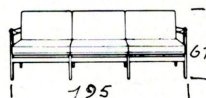
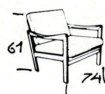
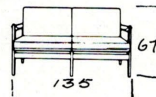

ILLUM WIKKELSØ

5

FACTS:

Side chair made by
N. Eilersen 1966.

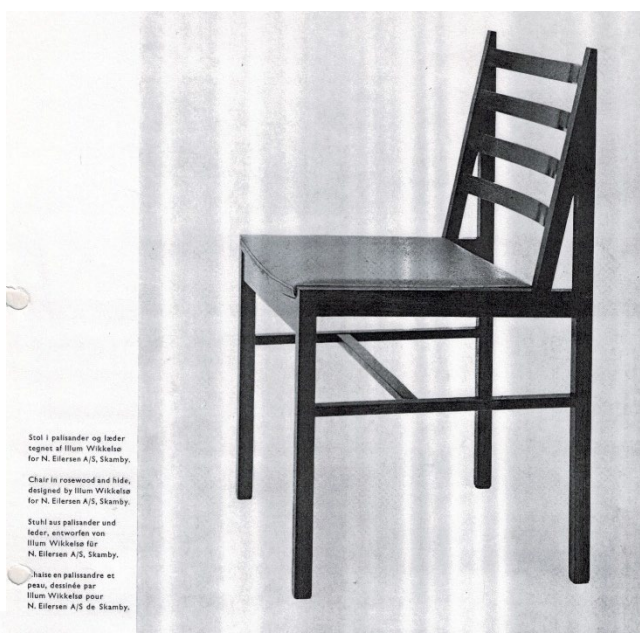

Stol i palissander og læder
tegnet af Illum Wikkelsø
for N. Eilersen A/S, Skamby.

Chair in rosewood and hide,
designed by Illum Wikkelsø
for N. Eilersen A/S, Skamby.

Stuhl aus palissander und
leder, entworfen von
Illum Wikkelsø für
N. Eilersen A/S, Skamby.

..haite en palissandre et
peau, dessinée par
Illum Wikkelsø pour
N. Eilersen A/S de Skamby.

Mobilia nr. 133, August 1966

ILLUM WIKKELSØ

6

FACTS:

Easy chair
Model:
HANDY – V10.

made by
Holger Christiansen 1964.



Dimension chair
H: 615 mm, W: 550 mm, D: 560 mm

There is also a side table in rosewood and leather.

The chair was bought by the emperor of Japan.



ILLUM WIKKELSØ

7

FACTS:

Easy chair model 272
Side table model 273
Footstool model 271

Made by:
C. F. Christensen

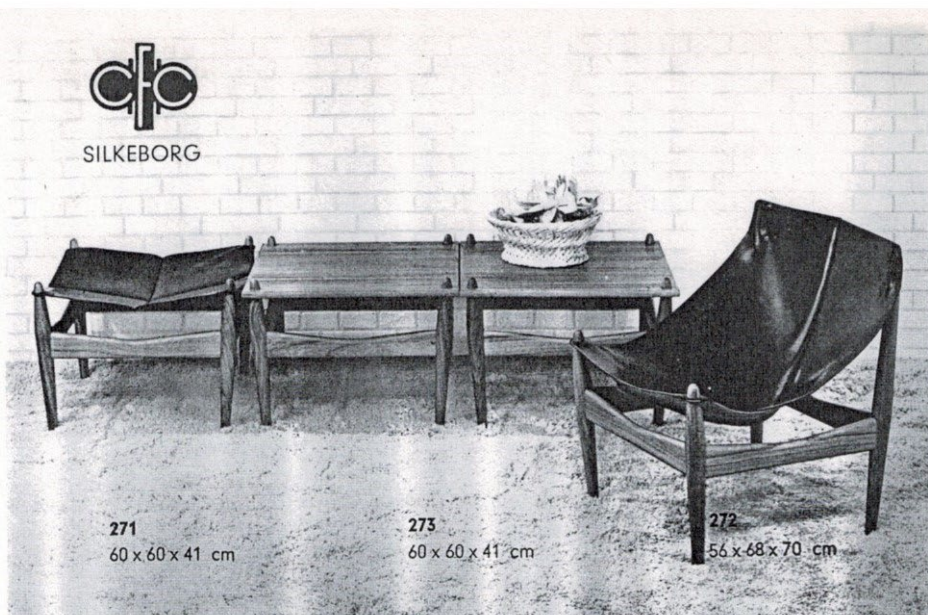

271
60 x 60 x 41 cm

273
60 x 60 x 41 cm

272
56 x 68 x 70 cm

Design Illum Wikkelsø

ILLUM WIKKELSØ

8

Model system
Easy chair, sofa and side
table
Made by
Hjørring Møbel-og
Madrasfabrik.



ILLUM WIKKELSØ

8.A

Sewing table
Part of
model system 8
Combination furniture

Made by: Hjørring Møbel- og
madrasfabrik



KOMBINATIONSMØBLER

TV

Sådan starter man. Det er grundelementet til en sofa, et siddeelement og én lille armstol samt to plader, der senere kan bruges til sofabordet.

II VAD skal man gøre, når pengene ikke er store, og man alligevel gerne vil have smukke, nye møbler? Det spekulerede Grete og Johan lidt over. Indtil de fandt disse smukke og hensigtsmæssige kombinationsmøbler, der kan stykkes sammen lidt efter lidt. Møbelhandleren fortalte dem, at man kan begynde med et grundelement f. eks. til en sofa samt to plader og et enkelt siddeelement. Derefter kan man udfylde med flere siddeelementer, og pladerne kan flyttes over på grundelementet til et sofabord. Og sådan kan man blive ved. Se blot på billederne. Møblerne er tegnet af arkitekt Illum Wikkelsø og fremstillet i Hjørring. Stoffet hedder Rapallo og er tegnet af arkitekt Torsten Johanson. Vejledende priser findes på side 69.

Der er på det nærmeste fuld møbleret. Der er et siddeelement, en fjernsynsramme i forgrunden og et sofabord samt to stole, den ene med armstol. Plader og siddeelementer passer over det hele. Opstillingen er foretaget af Ulf Møbler, København.

41

multi
BYGGEMØBLER

ARKITEKT - ILLUM WIKKELSØ

danish-modern.co.uk

OPSTILLING OVER DE
ALMINDELIGSTE KOMBINATIONSMULIGHEDER AF MULTI-MØBLER

EN PRAKTISK LØSNING
PRÆGET AF DÆRES INDIVIDUELLE SMAG!

ILLUM WIKKELSØ

9

FACTS:

Easy chair and sofa
Made by Holger Christiansen.
Model V.8.



ILLUM WIKKELSØ

10

FACTS:

Easy chair

Model 103

Made by

Hjørring Møbelfabrik.



ILLUM WIKKELSØ

11

FACTS:

Easy chair
Model DF15
Made by
Komfort/Dansk Form.



ILLUM WIKKELSØ

12

FACTS:

Easy Chair
Model: VIKING

Made by:
Holger Christiansen

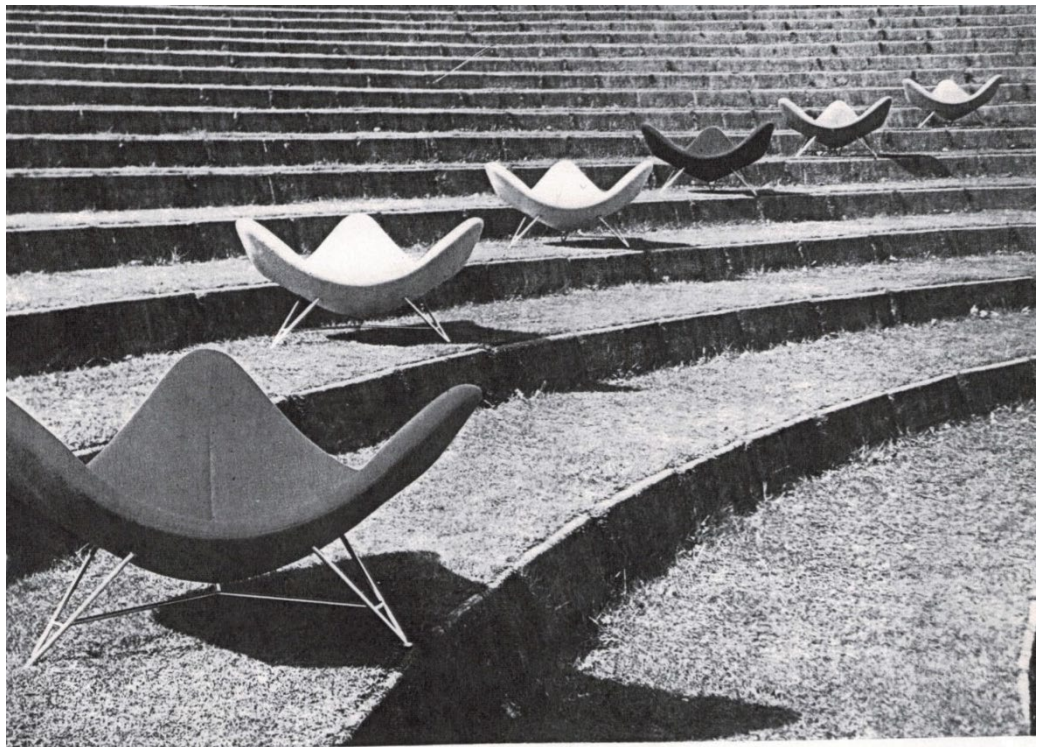

ILLUM WIKKELSØ

13

FACTS:

Easy chair, sofa and
coffee table
Model 80.
Made by
Søren Villadsen

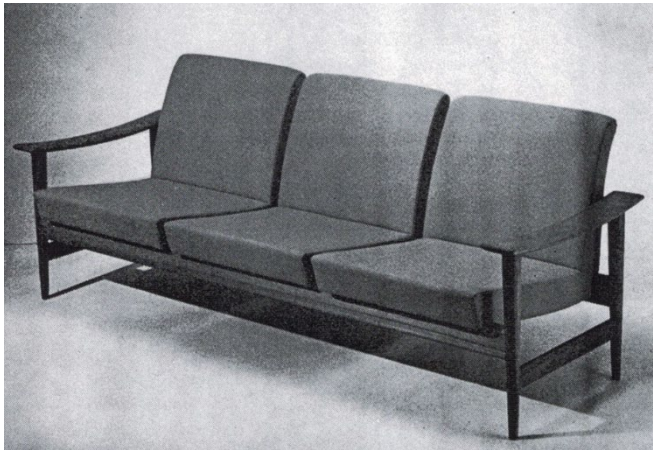

Sofa model 80/3



Opholdsstue nr. 80, teak, tegnet af arkitekt Illum Wikkelsø. Monteret med skumgummi.

ILLUM WIKKELSØ

14

FACTS:

High back chair
Model 111
Suite no. 110

Made by
Michael Laursen

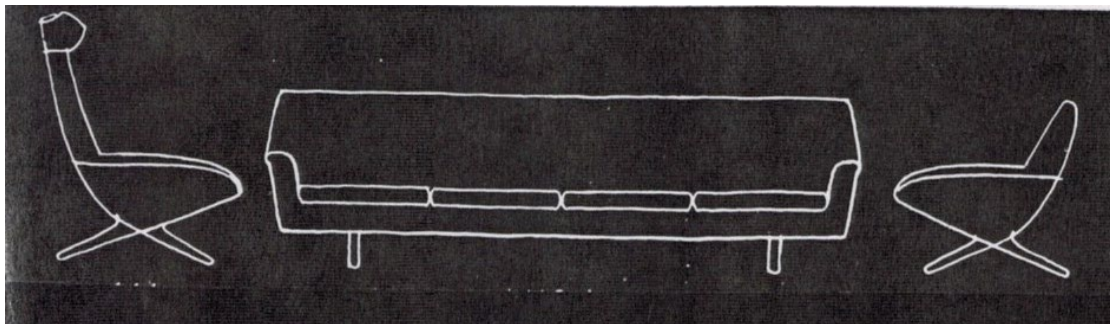

STUE NO.110-TEGNET AF ARKITEKT ILLUM WIKKELSØ

ILLUM WIKKELSØ

15

Sofa
Model ML 90
Made by Mikael Laursen



ILLUM WIKKELSØ

16

FACTS:

Easy chair and sofa
made by: N.Eilersen
Model No.4 Capella



In the late 1950s, as a profit from cutting, large quantities of cheap teak wood (in the size 1x2x24 English inches) came on the world market. Wikkelsø and Eilersen used it to make this chair, which is made of just such pieces. For example. the armrests are made in the same way as a cricket bat, in that two pieces are glued to the top of the armpit. The chair is part of a modular program where chairs could be assembled into sofas of infinite length. The furniture is also made of other types of wood than teak.



ILLUM WIKKELSØ

16A

FACTS:

High back chair
Made by N. Eilersen
Model No.4 Capella



Mobilia nr. 133, August 1966

ILLUM WIKKELSØ

16B

FACTS:

Capella no 4:
Chair, table and
high back sofa

Made by
N. Eilersen



Juhls Bolighus - Sønderborg - Danmark

2-68

Gruppe i læder eller stof
Polydunpuder
Eg - teak - palisander

Group in leather or fabric
Polydown-cushions
Oak - teak - rosewood

Gruppe in Leder oder Stoff
Poly-Downkissen
Eiche - Teak - Palisander

Design: Illum Wikkelsø

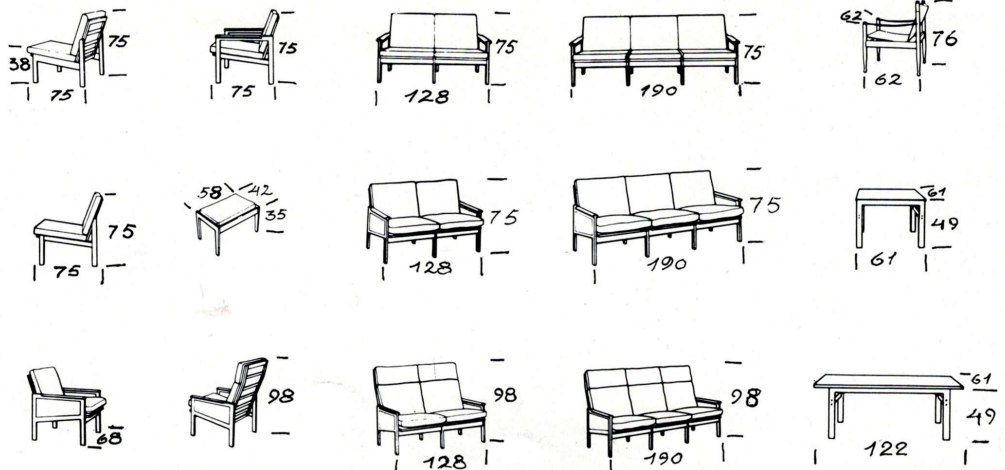

ILLUM WIKKELSØ

17

FACTS:

Cabinet, dining table and side chairs

Model 47

Made by
Dammand & Rasmussen

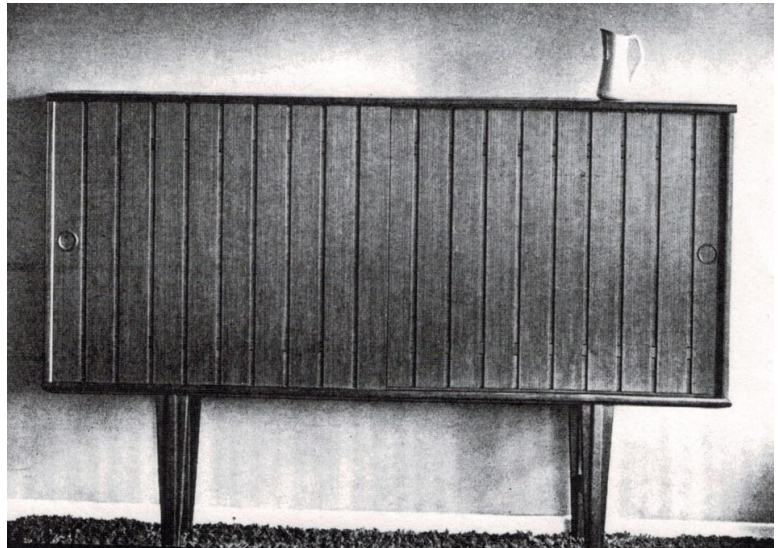

Cabinet made in teak H: 135 cm, W: 200, D: 45 cm.

Dinning table and chairs model 47. L: 176 W: 86 cm. Extra: 63 cm x 86 cm.

Bord og stole nr. 47
teak
plademål: 176 cm x 86 cm
klap: 63 cm x 86 cm



arkitekt: Illum Wikkelsø

DAMMAND & RASMUSSEN
Møensgade 8 . Aarhus . Danmark
Telf. 3 41 21

ILLUM WIKKELSØ

18

Easy chair
Model 465
Made by Aarhus
Polstrermøbelfabrik



danish-modern.co.uk

sofa, stol og bord nr. 465
tegnet af arkitekt Illum wikkelsø for
AARHUS POLSTRERMØBELFABRIK,
grønnegade 80, aarhus, danmark, telefon 061-23190



ILLUM WIKKELSØ

18.A

FACTS:

Easy chair, sofa and
coffee table

Model 465

Made by
Aarhus
Polstrermøbelfabrik



ILLUM WIKKELSØ

19

Rocking chair IW3

Easy Chair IW2

Dining chair IW5

Made by N. Eilersen Denmark.

Model IW5 Total depth: 58 cm · Seat height: 45 cm · Total height: 102 cm



ILLUM WIKKELSØ

20

FACTS:

Table
Made by
Hjørring Møbelfabrik

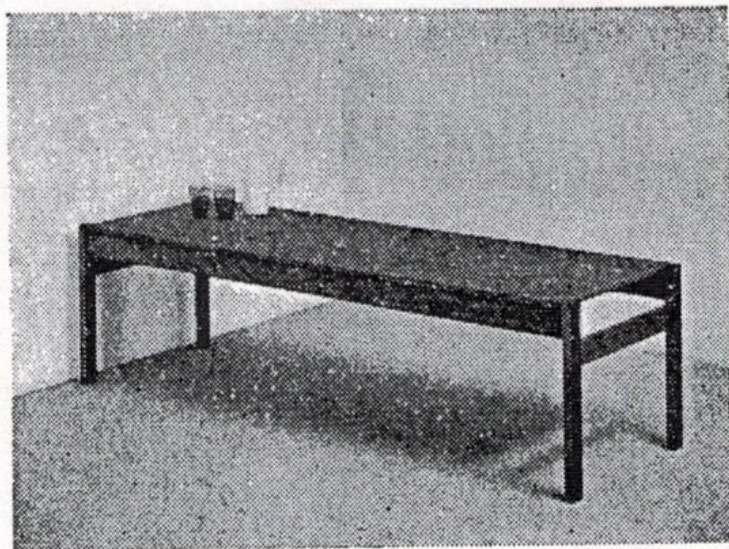

T.V. bord, 3 plader Teak
Arkitekt Illum Wikkelsø
Kr. 298,—

GOD FORM

Det 48. Danske Købestævne 1958, Fredericia

ILLUM WIKKELSØ

21

FACTS:

Table
Made by
Hjørring Møbelfabrik 1958



T.V. bord, 1 plade m. hjul Teak
Arkitekt Illum Wikkelsø
Kr. 170,—

GOD FORM

Det 48. Danske Købestævne 1958, Fredericia

ILLUM WIKKELSØ

22

FACTS:

Cabinet no. 77
Dining table and
side chairs
no.30

Made by
Søren Villadsen.

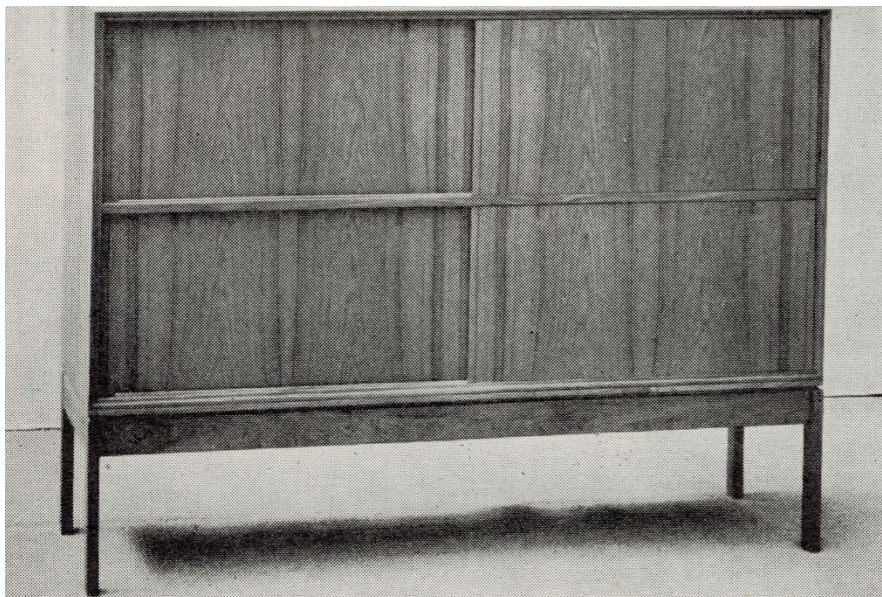

Øverst: Dækketøjsskab nr. 77 tegnet af arkitekt Illum Wikkelsø. Fremstilles i teak. Skabet er med skydedøre med messinggreb, indvendige sølv-tøjsskuffer og stilbare hylder.

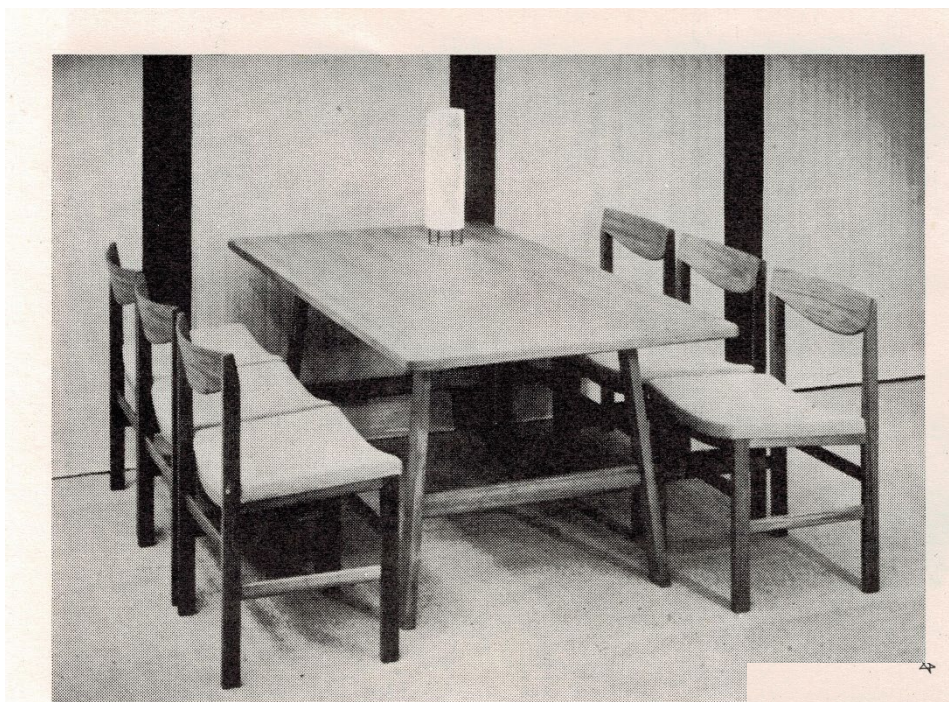

Nederst: Spisebord og stole nr. 30 tegnet af arkitekt Illum Wikkelsø. Fremstilles i teak. Stolene er monteret med skumgummi.

ILLUM WIKKELSØ

23

FACTS:

Coffee table
Made by
Mikael Laursen

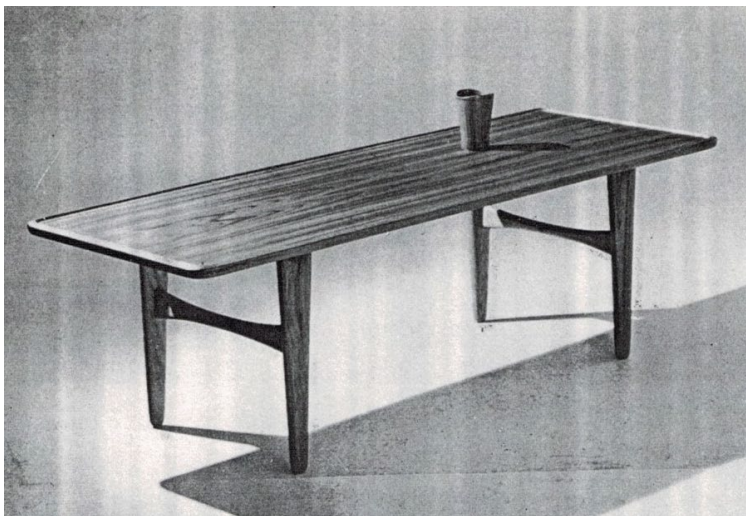

Sofatisch aus Teakholz, gezeichnet vom Architekten Illum Wikkelsø für Mikael Laursen.

ILLUM WIKKELSØ

24

FACTS:

Easy chair, sofa and coffee table. No.10
Made by
Søren Villadsen

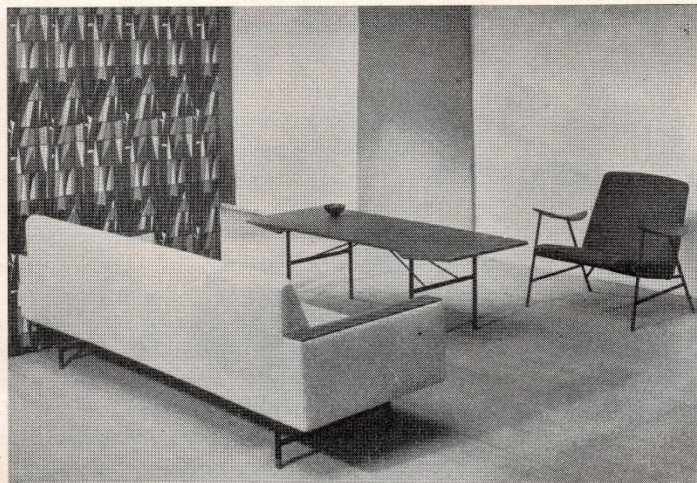

Opholdsstue nr. 10

Tegnet af arkitekt
ILLUM WIKKELSØ

SØREN WILLADSENS MØBELFABRIK
VEJEN

TELEFON VEJEN 36

ILLUM WIKKELSØ

25

FACTS:

Side chair
Model 56
Made by
Gordum & Nielsen 1957



Stol nr. 56. Eg/teak.

Arkitekt Illum Wikkelsø

BORDUM & NIELSEN

BRABRAND . Telefon Aarhus (061) 60233



ILLUM WIKKELSØ

26

FACTS:

Sofa, chair
and coffee table

In Yellow
modified armrest

Model 10 A

Made by
Søren Villadsen

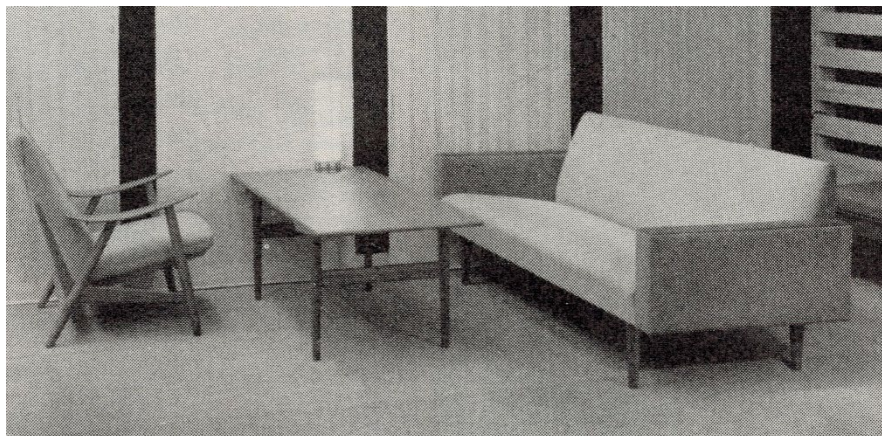

ILLUM WIKKELSØ

26A

FACTS:

High back chair

Model: 10H.

Made by

Søren Willadsen møbelfabrik



ILLUM WIKKELSØ

27

FACTS:

Easy chair
Model Poet chair, 190
Made by
Farstrup Savværk



ILLUM WIKKELSØ

28

FACTS:

Sofa
Model 185
Made by
Hjørring Møbel- og
madrassfabrik



Sofa HM 185 . Eg

Arkitekt Illum Wikkelsø

ILLUM WIKKELSØ

29

FACTS:

Cabinet
model 90
made by
Søren Villadsen.



This cabinet was designed by Illum Wikkelsø and produced by Danish company Søren Willadsen in the 1950s. The cabinet features three sliding doors hiding shelves and drawers. The cabinet is made of veneered teak while the frame is made of oak. It has some small dents (see photos) but overall is in very good condition. The model 90 was first presented in 1953.

dimensions

H: 51.19 in. W: 63 in. D: 17.33 in.

H: 130 cm, W: 160 cm D: 44 cm

ILLUM WIKKELSØ

30

FACTS:

Easy chair
Model: H.M.101
Made by
Hjørring Møbel-og
Madrasfabrik

Se next page 30.A. for sofa
model H.M.101/2



ILLUM WIKKELSØ

30.A

FACTS:

Sofa.
HM 101-2
Made by
Hjørring Møbel-og
madrasfabrik

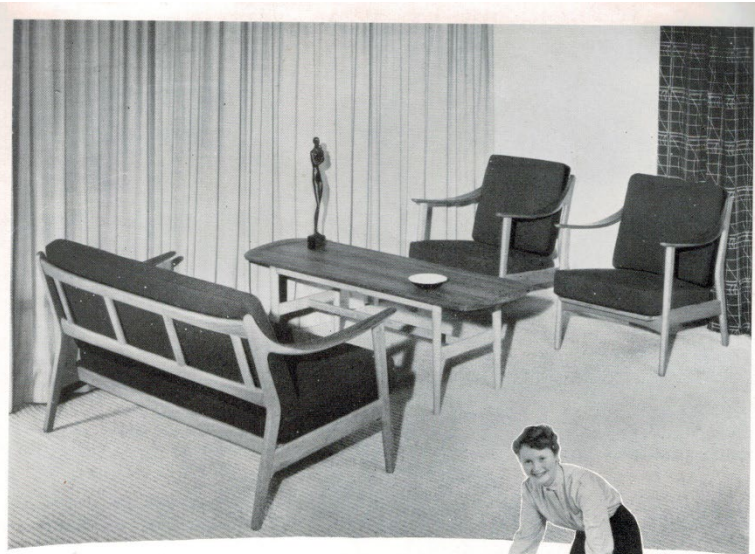

TEGNET AF ARKITEKT ILLUM WIKKELSØ

MODEL:

Stol H.M. 101 — Sofa H.M. 101/2

TRÆSORTER:

Eg og teak — Bøg, nød farvet

HYNDER:

Monteret med springindlæg

SÆDERAMMER:

Monteret med gummigjorde



COMMENTS

See also same model as easy chair. nr.30

Sofa model H.M.101/2

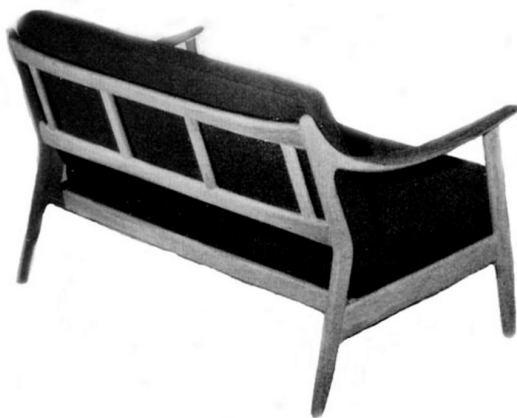

FACTS:

Installation no. 92
Cabinet, chair
and dining table
Made by
Søren Villadsen
Møbelfabrik

Side chair no. 90 see
next page.

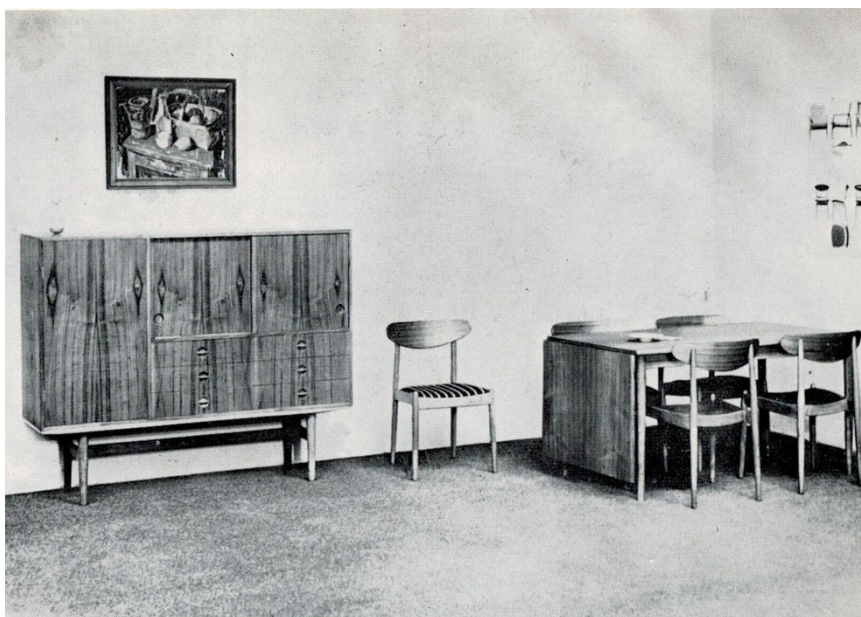

Spisestue nr. 92 . Eg/teak

Tegnet af
arkitekt Illum Vikkelsø

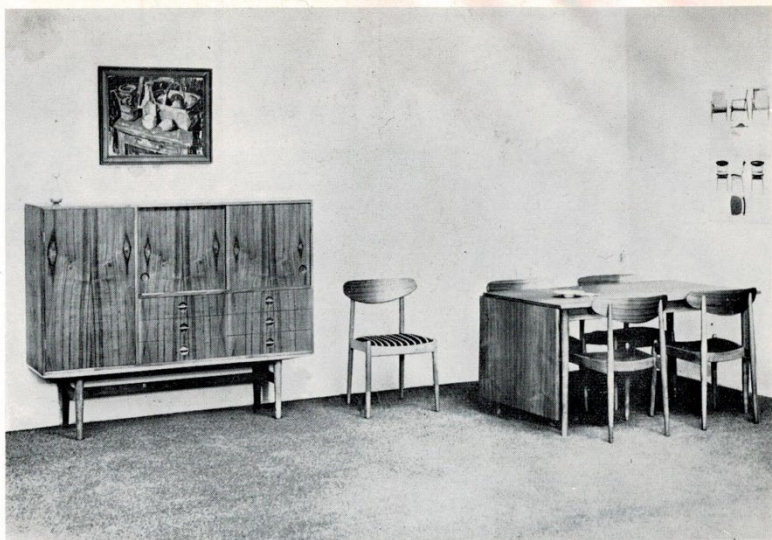

SØREN WILLADSENS MØBELFABRIK 1/s . VEJEN

TELEFON 35 og 36 Omst. til Søren Willadsen privat
J. D. Lawaetz privat Telefon 328

ILLUM WIKKELSØ

31.A

Side chair nr. 90
Made by:
Søren Willadsen`s Furniture
Factory



Stol nr. 90,
tegnet af arkitekt Illum Wikkelsø.
Eg/teak - nød.

M
Ø
B
L
E
R

SØREN WILLADSENS
MØBELFABRIK I/S,
VEJEN

TELF. 36 (2 LIN.)

ILLUM WIKKELSØ

32

FACTS:

Side chair
Model 55
Made by
Bordum & Nielsen,
Brabrand. Denmark



ILLUM WIKKELSØ

33

FACTS:

Sofa bed HM 1
Made by
Hjørring Møbelfabrik 1955



Enkelt sovesofa HM 1 — eg|teak . Arkitekt Illum Wikkelso



ILLUM WIKKELSØ

34

FACTS:

Sofa Model 50-4.

Made by

A. Andersen & Bohm



ILLUM WIKKELSØ

35

FACTS:

Arm chair.
Model 25GTU
Made by
Aage Pedersen



ILLUM WIKKELSØ

36

FACTS:

Easy chair model 451
Made by
Aarhus Polster Møbelfabrik in
Denmark 1958



Dimensions

H: 30.32 in. W: 30.71 in. D: 27.56 in.
H: 77 cm W: 78 cm D: 70 cm

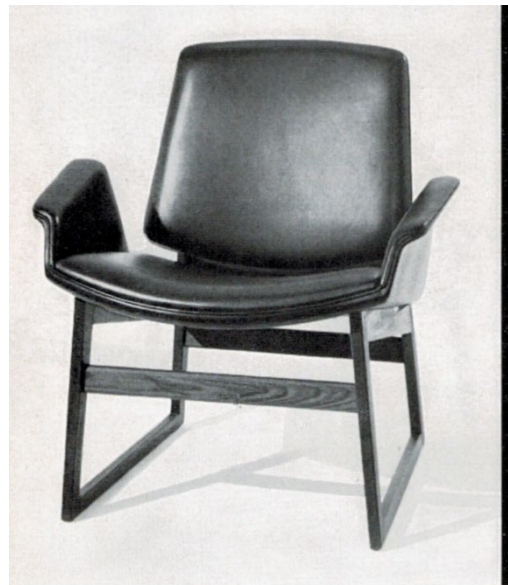

Easy-Chair. No. 18272
Design: Illum Wikkelsø
Teak Leather. Rosewood/Leather
Width: 72 cm.
Depth: 70 cm.
Height: 74 cm.

ILLUM WIKKELSØ

36.A

FACTS:

'Double Shell' Lounge Chairs
by Illum Wikkelsø for Arflex,
Italy, 1960



Pair of 'double shell' lounge chairs designed in 1960 by Danish designer Illum Wikkelsø for Italian manufacturer Arflex. The October 1962 issue of 'DOMUS' confirms that the 'double shell' lounge made its debut in 1960.

Dimensions

H: 29.14 in. W: 30.32 in. D: 23.63 in. H: 74 cm W: 77 cm D: 60 cm
Seat height 14.97 in. (38 cm)

ILLUM WIKKELSØ

37

FACTS:

Armchair
Model ML91
made by Mikael Laursen

Dimensions

H: 33.47 in. W: 35.44 in. D:
38.19 in.

H: 85 cm W: 90 cm D: 97 cm

Seat height 14.57 in. (37 cm)



ILLUM WIKKELSØ

38

FACTS:

Shelving system
1961.

Made by
Søren Villadsen. Denmark

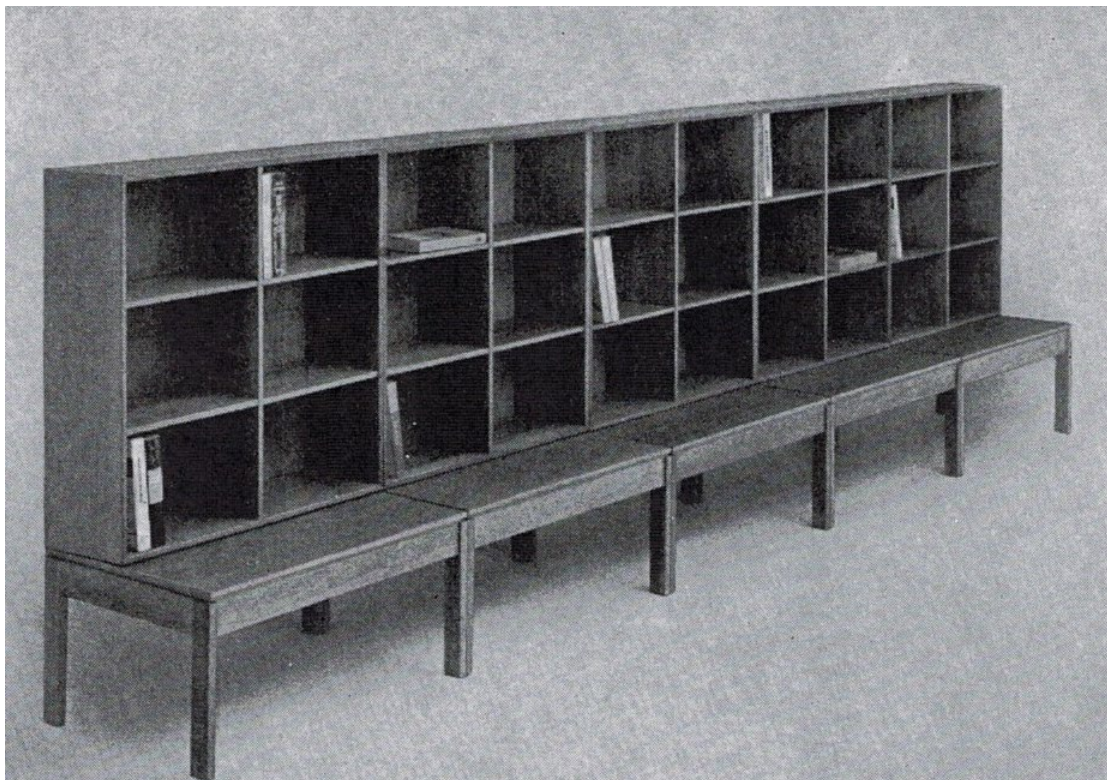

Bygge og Bo, 27. årgang. Marts 1961. Hefte 1

ILLUM WIKKELSØ

39

FACTS:

Dining table Model 185
Chairs Model 188

Made by
Farstrup Savværk &
Stolefabrik a/s



Stol nr. 188

Bord nr. 185

Arkitekt Illum Wikkelsø

TLF. VEFLINGE 28

FARSTRUP SAVVÆRK & STOLEFABRIK $\frac{A}{S}$

ILLUM WIKKELSØ

39.A

FACTS:

Installation:
Cabinet, dining chair and
table.

Made by
Farstrup Savværk

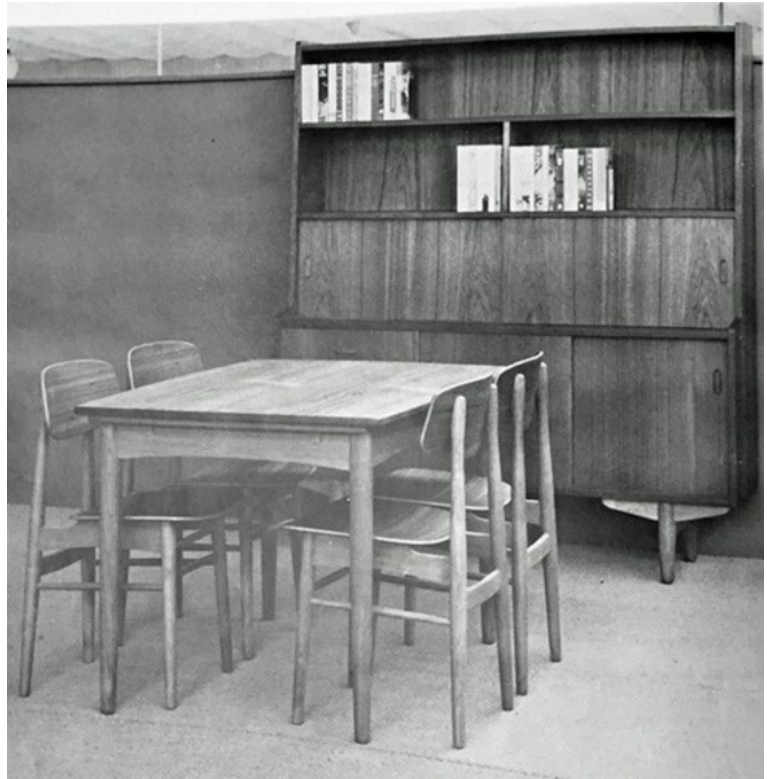

ILLUM WIKKELSØ

39.B

FACTS:

Side chair Model 188

Made by
Farstrup Savværk (1956)



Se also nr. 39 and 39A.



ILLUM WIKKELSØ

40

FACTS:

Easy chair, sofa and table.
Model V12.

Made by
Holger Christiansen



Dimensions

Sofa H: 69 cm, W: 142 cm D 67 cm.

Chair H: 68 cm, W: 78 cm D: 67 cm.

Table L: 130 cm, W: 70 cm, H: 50 cm, or LxW 100 cm H: 50 cm.

Table top leather covered.



ILLUM WIKKELSØ

41

FACTS:

Furniture group

Model 50

Made by N. Eilersen



ILLUM WIKKELSØ

42

FACTS:

Easy chair and sofa
Model V17
Made by:
Holger Christiansen



Model V 17. Sofa available for 2 and 3 persons. With buff upholstery, fibre-fill-cushions and legs in Brazilian rosewood. Maximum external dimensions: 2 persons: width 1.55 m, depth 0.70 m, height 0.72 m. 3 persons: width 2.15 m, depth 0.70 m, height 0.72 m. Chair with same upholstery and cushions as sofas. Maximum external dimensions: width 0.82 m, depth 0.70 m, height 0.72 m.

ILLUM WIKKELSØ

43

FACTS:

Easy chair and sofa
Model 459
Made by
Aarhus Møbelfabrik 1958

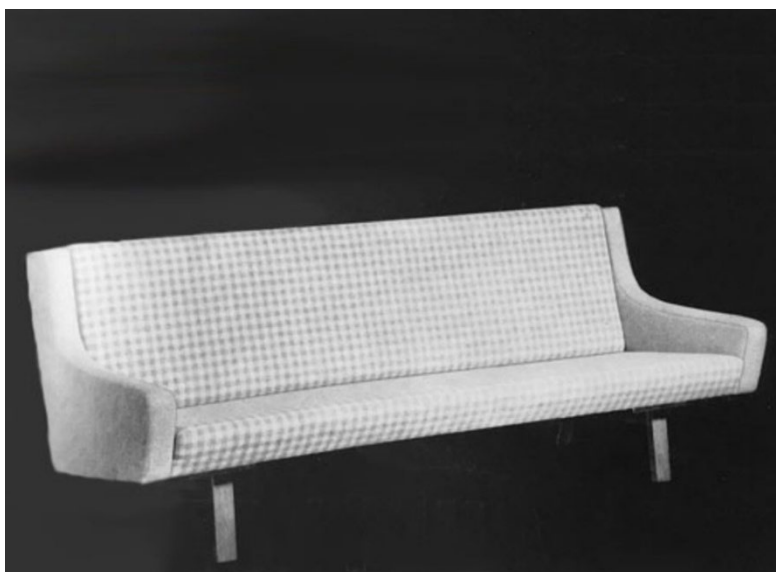

ILLUM WIKKELSØ

44

FACTS:

Easy chair,
model 23.
Made by N. Eilersen.



Also called "Ringstol"

Dimensions

H: 28 in. W: 31.5 in. D: 30 in. H: 71.12 cm W: 80.01 cm D: 76.2 cm

Seat height 14 in. (35.56 cm)

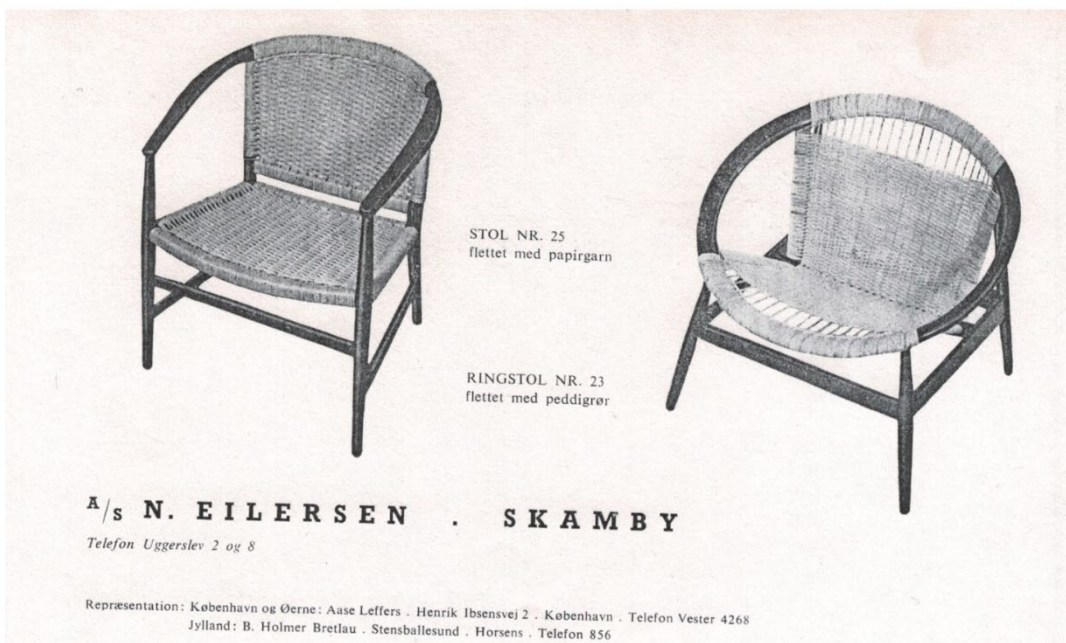

A/S N. EILERSEN . SKAMBY

Telefon Uggerslev 2 og 8

Repræsentation: København og Øerne: Aase Leffers . Henrik Ibsensvej 2 . København . Telefon Vester 4268
Jylland: B. Holmer Bretlau . Stensballe Sund . Horsens . Telefon 856

ILLUM WIKKELSØ

45

FACTS:

Easy chair Model 25
Made by
N. Eilersen 1956

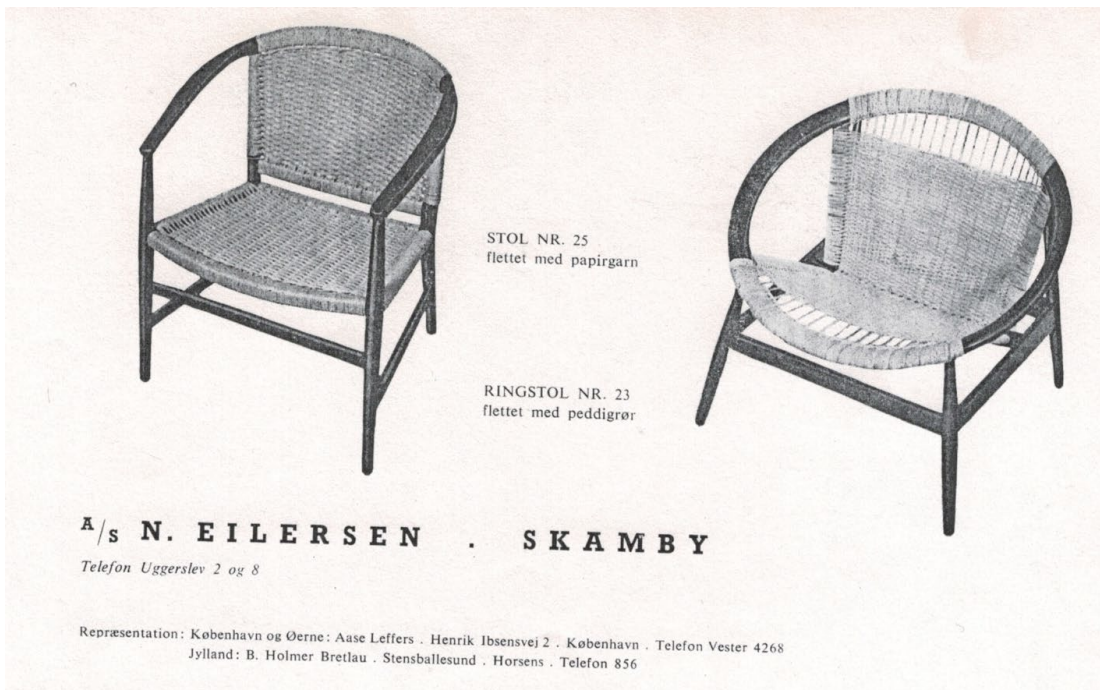
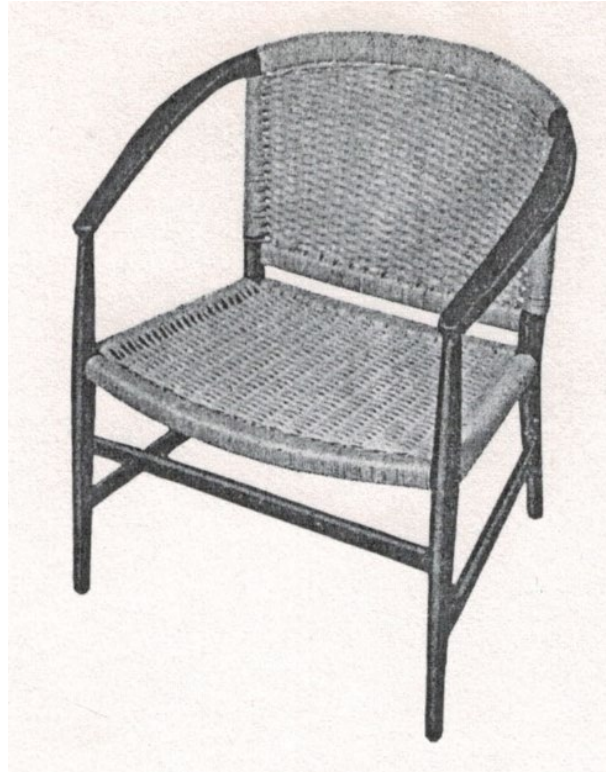

ILLUM WIKKELSØ

46

FACTS:

Sofa and chair
Model V11

Originally made by Holger
Christiansen, Århus.

Since 2019 GUBI has exclusive
rights to produce V 11.



ILLUM WIKKELSØ

47

Armchair and sofa

Model: **WIK**

Made by:

Koefoed's Furniture

Hornslet

Denmark



»WIK«
teak

Dimensions

H: 28.35 in. W: 27.56 in. D: 26.78 in.

H 72 cm W: 70 cm D: 68 cm

Seat height 14.97 in. (38 cm)

ILLUM WIKKELSØ

47.A

Table
Model: WIK
Made by:
Koefoed's Furniture
Hornslet
Denmark

COFFEE TABLE »WIK«
L 58" W 23½" H 19"



Sofabord »WIK« teak - palisander
L 148 B 60 H 48 cm
2 udtæk á 40 cm

Also available as coffee table "WIK"
L:58 in. W: 23½ in. H: 19 in.



ILLUM WIKKELSØ

48

FACTS:

Easy chair
Model 50-1
Made by Søren Villadsen



Model 50 as 3 or 4 seated
sofas see 61



ILLUM WIKKELSØ

49

FACTS:

Easy chair
Model Plexus
Made by C. F. Christensen



COMMENTS

Dimensions

H: 25.6 in. W: 21.26 in. D: 20.08 in. H: 65 cm W: 54 cm D: 51 cm

Seat height 15.75 in. (40 cm)



ILLUM WIKKELSØ

49.A

FACTS:

Plexus sofa
Made by
C. F. Christensen.



ILLUM WIKKELSØ

49.B

FACTS:

Side tables
Model: Plexus
made by
C. F. Christensen.



Samples



611

bord, adskilleligt
underdel massiv
plade fineret

table KD
base solid
top veneer

Tisch, zerlegbar
Gestell massiv
Platte furniert

57 x 57 cm H: 34 cm
52 cm/57 cm
22½" x 22½" H: 13½"
20½"/22½"

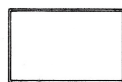

612

bord, adskilleligt
underdel massiv
plade fineret

table KD
base solid
top veneer

Tisch, zerlegbar
Gestell massiv
Platte furniert

92 x 57 cm H: 34 cm
52 cm/57 cm
36" x 22½" H: 13½"
20½"/22½"

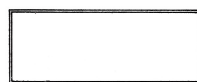

613

bord, adskilleligt
underdel massiv
plade fineret

table KD
base solid
top veneer

Tisch, zerlegbar
Gestell massiv
Platte furniert

142 x 57 cm H: 34 cm
52cm/57 cm
56" x 22½" H: 13½"
20½"/22½"

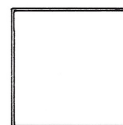

614

bord, adskilleligt
underdel massiv
plade fineret

table KD
base solid
top veneer

Tisch, zerlegbar
Gestell massiv
Platte furniert

92 x 92 cm H: 34 cm
52 cm/57 cm
36" x 36" H: 13½"
20½"/22½"

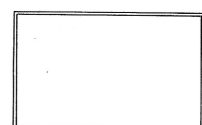

615

bord, adskilleligt
underdel massiv
plade fineret

table KD
base solid
top veneer

Tisch, zerlegbar
Gestell massiv
Platte furniert

142 x 92 cm H: 34 cm
52 cm/57 cm
56" x 36" H: 13½"
20½"/22½"

ILLUM WIKKELSØ

49.C

FACTS:

Trolley model no. 617
Made by
C. F. Christensen.



617

serveringsvogn,
adskillelig
underdel massiv
plader sort linoleum

serving trolley KD
base solid
tops with black
linoleum

Servierwagen,
zerlegbar
Gestell massiv
Platten: schwarzes
Linoleum

92 x 57 cm H: 57 cm
36" x 22½" H: 22½"

ILLUM WIKKELSØ

49.D

Overview

Model: Plexus

Illum Wikkelsø

Made by:
C.F.Christensen



600

taburet, adskillelig
træ massivt
pude polydun
på gummigjorde

stool KD
wood solid
cushion polydowns
on rubber straps

Hockér, zerlegbar
Holz massiv
Kissen Polydaunen
auf Gummigurten

57 x 57 cm H: 34 cm
22½" x 22½" H: 13½"



601

stol uden arme,
adskillelig
ryg med rørlet
træ massivt
puder polydun
på gummigjorde

chair no arms KD
back with cane
wood solid
cushions polydowns
on rubber straps

Sessel ohne Arm-
lehnen, zerlegbar
Rücken mit Rohr-
geflecht
Holz massiv
Kissen Polydaunen
auf Gummigurten

57 x 57 cm H: 65 cm
22½" x 22½" H: 25½"



602

stol med 1 arm,
adskillelig
ryg og arm med rørlet
træ massivt
puder polydun
på gummigjorde

chair with 1 arm KD
back and arm with cane
wood solid
cushions polydowns
on rubber straps

Sessel mit einer
Armlehne, zerlegbar
Rücken und Armlehne
mit Rohrgeflecht
Holz massiv
Kissen Polydaunen
auf Gummigurten

57 x 57 cm H: 65 cm
22½" x 22½" H: 25½"

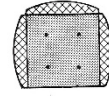

603

stol med 2 arme,
adskillelig
ryg og arme med rørlet
træ massivt
puder polydun
på gummigjorde

chair with 2 arms KD
back and arms with
cane
wood solid
cushions polydowns
on rubber straps

Sessel mit 2
Armlehnen, zerlegbar
Rücken und Armlehnen
mit Rohrgeflecht
Holz massiv
Kissen Polydaunen
auf Gummigurten

57 x 57 cm H: 65 cm
22½" x 22½" H: 25½"



631

stol uden arme,
adskillelig
ryg polstret
træ massivt
puder polydun
på gummigjorde

chair no arms KD
back upholstered
wood solid
cushions polydowns
on rubber straps

Sessel ohne Armlehnen
zerlegbar
Rücken gepolstert
Holz massiv
Kissen Polydaunen
auf Gummigurten

57 x 57 cm H: 65 cm
22½" x 22½" H: 25½"



632

stol med 1 arm
ryg og arm polstret
træ massivt
puder polydun
på gummigjorde

chair with 1 arm KD
back and arm upholst.
wood solid
cushions polydowns
on rubber straps

Sessel mit einer
Armlehne,
zerlegbar
Rücken und
Armlehne gepolstert
Holz massiv
Kissen Polydaunen
auf Gummigurten

57 x 57 cm H: 65 cm
22½" x 22½" H: 25½"

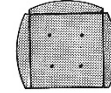

633

stol med 2 arme
adskillelig
ryg og arme polstret
træ massivt
puder polydun
på gummigjorde

chair with 2 arms KD
back and arms upholst.
wood solid
cushions polydowns
on rubber straps

Sessel mit 2 Armlehnen
zerlegbar
Rücken und
Armlehnen gepolstert
Holz massiv
Kissen Polydaunen
auf Gummigurten

57 x 57 cm H: 65 cm
22½" x 22½" H: 25½"



616

blomsterbord,
adskilleligt
underdel massiv
blomsterkasse acryl

flowertable KD
base solid
tray acryl

Blumentisch, zerlegbar
Gestell massiv
Schale Acryl

57 x 57 cm H: 34 cm
22½" x 22½" H: 13½"

ILLUM WIKKELSØ

50

FACTS:

Highback chair Model 445

Made by Aarhus
Polstermøbelfabrik



ILLUM WIKKELSØ

50.A

FACTS:

Sofa Model 444

Made by
Aarhus Møbelfabrik

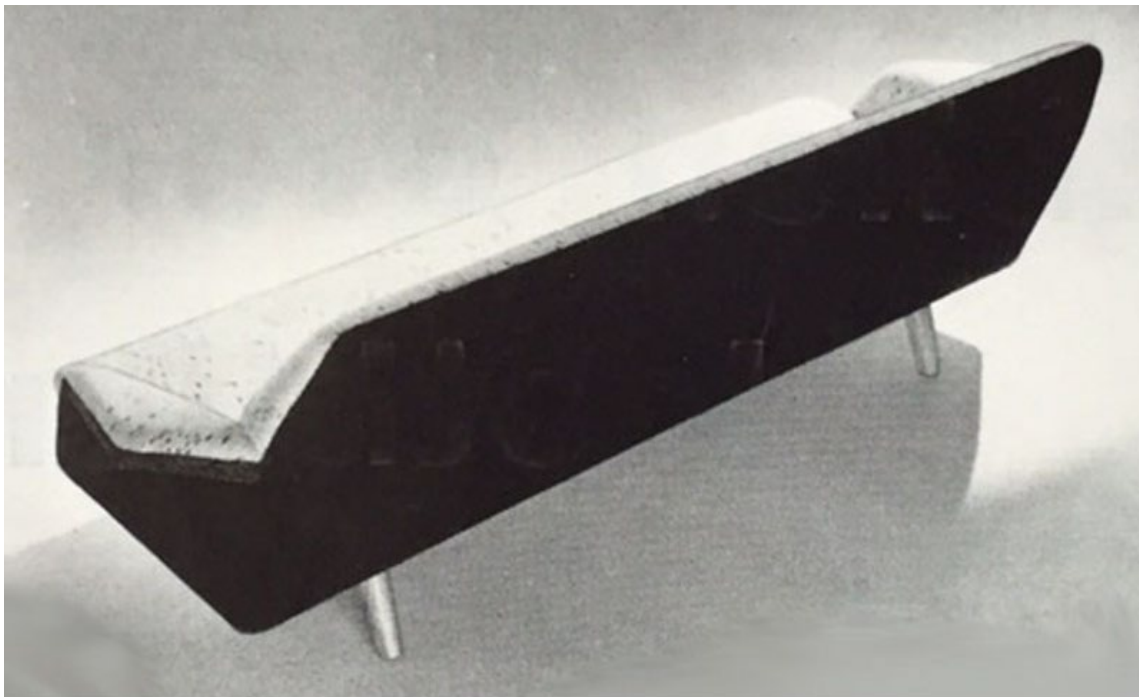

ILLUM WIKKELSØ

51

FACTS:

Easy chair, sofa
and coffee table
Model 40.

Made by
Søren Villadsen.

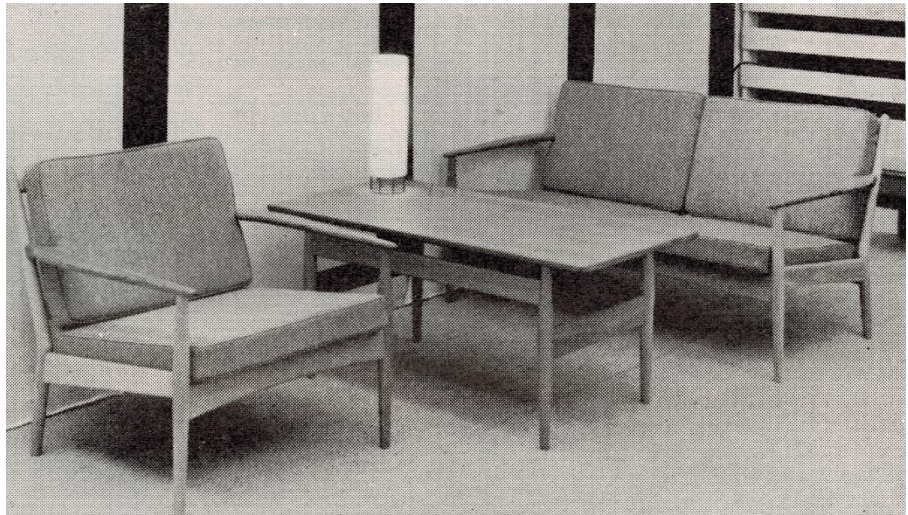

Midten: Lænestol, sofa og sofabord nr. 40 tegnet af arkitekt Illum Wikkelsø. Fremstilles i røgfæret eg med teakarmstæn, løse skumgummi-hynder med lynlås. Møblerne er til at skille ad, hvilket betyder en stor lettelse for husmoderen, der skal gøre rent i stuerne. Desuden er møblerne lette at flytte, da de ikke vejer ret meget i forhold til tidligere tiders tunge møbler.

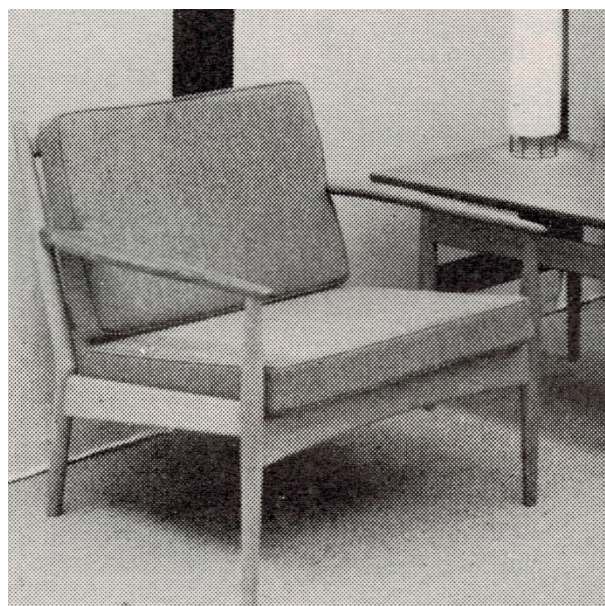

ILLUM WIKKELSØ

52

FACTS:

Highback and lounge chair.
Model 50

Made by
Søren Villadsen.



Dimensions highback chair:

H: 37.41 in. W: 29.53 in. D: 29.53 in. H: 95 cm, W: 75 cm. D: 75 cm

Seat height 14.18 in. (36 cm)



Model 50 lounge chair

ILLUM WIKKELSØ

52.A

FACTS:

Group 50
Chairs, 4 seated sofa and
coffee table
Made by
Søren Villadsen.



Opholdsstue nr. 50
(sofa 50/4,
hvilestol 50,
lænestol 50,
sofabord 50/170)

Tegnet af
arkitekt
Illum Wikkelso



Søren Willadsens Møbelfabrik
Vejen

ILLUM WIKKELSØ

53

FACTS:

Installation:
Highback chair, sofa and
coffee table.

Model HM.113

Made by
Hjørring Møbelfabrik



ILLUM WIKKELSØ

54

FACTS:

Installation:
Highback chair,
sofa and
coffee table.
Model HM.208

Made by
Hjørring Møbel-og
madrasfabrik

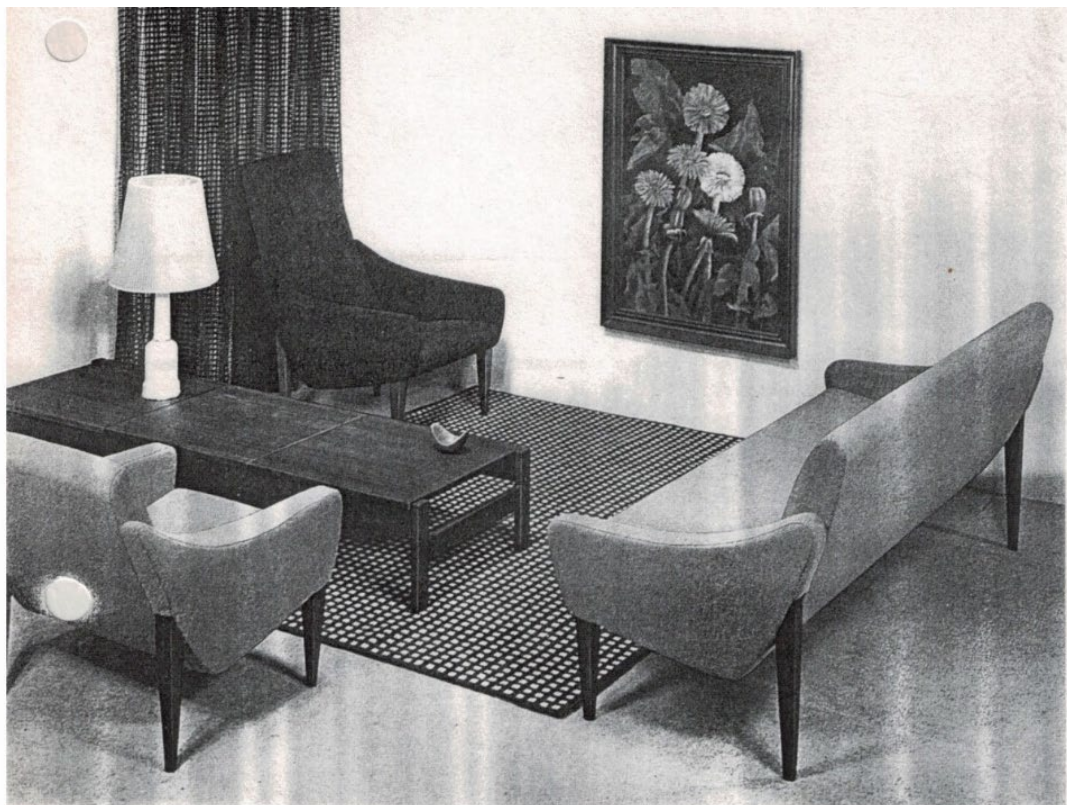

HM 208: Sofa med høj og lav stol

HM 208: Sofa with high and low armchair

HM 208: Sofa mit hohem und niedrigem Sessel

ILLUM WIKKELSØ

55

FACTS:

Furniture group:
Sofa, easy chair model 181
coffee table model 183

Made by
Farstrup Savværk &
Stolefabrik



ILLUM WIKKELSØ

56

FACTS:

H-serie
Made by
Hjørring Møbel-
og Madrasfabrik



From Modulia 86. sept.1967

The H-line is a child of
the TV-age.
- The chances for variations
are plenty and make
the H-line ideal as
border-furniture.



ILLUM WIKKELSØ

57

FACTS:

Chairs and table

Unknown producer

Chairs made in oak

Cushion in canvas

Table with 4 cm thick table top



Illum Wikkelsøs nye siddegruppe. Stole og bord er i massiv eg, stolene beklædt med canvas, og den gedigne bordplade er 4 cm tyk.

FACTS:

Chair and sofa
Model Tellus

Made by
C. F. Christensen. 1976



From the newspaper Jyllands-Posten April, 1976.

Kønne og solide fyrretræs- møbler til sommerhuset

**Polstrede
møbler, der
er beregnet
til at
slappe af i**

så bordets længde kan blive 2,20 meter. Prisen (den vejledende) er lidt under 2000 kroner. Ligeledes massive og enkle fyrretræsstole med højere eller lavere ryg koster fra ca. 350 kroner til ca. 370 kroner. Et andet bord er forsynet med to klapper— hver 60 cm lange — samme længde som den faste del af bordet, der samtidig er en meter bredt. Det giver 1,80 cm bord for ca. 1600 kroner. Et

En hvile- og hyggegruppe er absolut ikke overflødig i fritidshuset. En billig og alt andet end kedelig løsning er stalmøbelserien Senator fra Homa. Møblerne er fremstillet af 70 mm rektangulære stålrør og er plastbehandlet med en mat, sort finish, som giver en smuk overflade. Hynderne er bestrøket med finsk bomuldsstof i en stor tern, der passer til linjerne i møblerne. Prisen for

en hel møbelgruppe omfattende 3-personers sofa, to-personers sofa, stol og bord vil være ca. 2500 kroner.

I en anden, mere eksklusiv klasse er serien Tellus fra C. F. Christensen A/S og tegnet af Illum Wikkelsø. Prisen for en tre-personers sofa i denne serie er ca. 5000 kroner (med udvalgt stof), for en to-personers ca. 3500 kroner, for armstol ca. 1800 kr. Sofabordet koster ca. 760 kr. og hjørnebordet ca. 525

ILLUM WIKKELSØ

59

FACTS:

Sofa coffee table model 450

Made by
Århus Møbelfabrik



Dimensions

H: 29.13 in. W: 84.6/ 102,4 in. D: 31.5 in. H: 74 cm, W: 215/260 cm D: 80 cm



Sofa. No. 28144
Design: Illum Wikkelsø
Length: 215/260 cm.
Width: 80 cm.
Height: 74 cm.

ILLUM WIKKELSØ

60

FACTS:

Sofa Model 110
Made by
Søren Villadsen



ILLUM WIKKELSØ

60.A

FACTS:

Hichback lounge chair Model 110

Made by Søren Villadsen

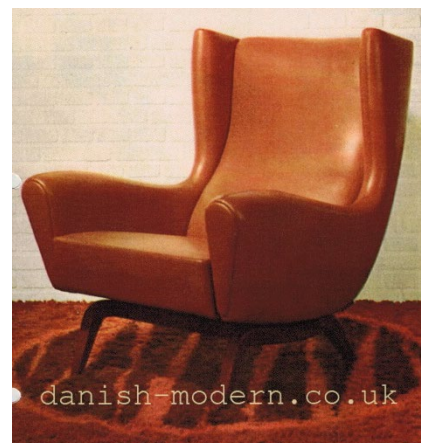

danish-modern.co.uk

hvilestol nr. 110
palisander, teak eller stål
design: Illum Wikkelsø
fås hos førende møbelhandlere



**SØREN
WILLADSENS
MØBELFABRIK
VEJEN**



ILLUM WIKKELSØ

61

FACTS:

Sofa model SV 50-4
Made by
Søren Villadsen.

Also as three seated:
Model SV 50-3.

See also number 48 and 52A



Dimensions 50-4

H: 29.5 in. W: 105 in. D: 30 in. H: 74.93 cm W: 266.7 cm D: 76.2 cm
Seat height 16 in. (40.64 cm)

Dimensions 50-3

H: 27.96 in. W: 81.89 in. D: 31.11 in. H: 71 cm W: 208 cm D: 79 cm
Seat height 15.75 in. (40 cm)



SØREN WILLADSENS MØBELFABRIK

Byggog bo. Summer 1959

ILLUM WIKKELSØ

61A

FACTS:

Sofa model SV 50-4 made by Søren Villadsen.
Also as three seated:
Model SV 50-3.



COMMENTS

dimensions 50-4

h 29.5 in. x w 105 in. x d 30 in. h 74.93 cm x w 266.7 cm x d 76.2 cm seat height 16 in. (40.64 cm)

dimensions 50-3

h 27.96 in. x w 81.89 in. x d 31.11 in. h 71 cm x w 208 cm x d 79 cm seat height 15.75 in. (40 cm)



SØREN WILLADSENS MØBELFABRIK

Byggog bo. Summer 1959

ILLUM WIKKELSØ

62

FACTS:

Sofa

Made by
Ryesberg
Møbelfabrik



Made as 2 seat and 3 seat.
Made with steel legs and mahogany legs.
From Design museum Denmark

Ryesberg, se also no. 64.



ILLUM WIKKELSØ

63

FACTS:

Sofa ML230 and
lounge chair ML 232

Made by Mikael Laursen



Dimensions

H: 27.56 in. W: 84.65 in. D: 33.47 in. H: 70 cm, W: 215 cm, D: 85 cm

Coffee table with legs of steel. See no. 113E

ILLUM WIKKELSØ

64

FACTS:

Sofa
Made by Ryesberg Møbler

Dimensions

H: 28 in. W: 88 in. D: 33.5 in.
H: 71.12 cm W: 223.52 cm D:
85.09 cm

Seat height
15 in. (38.1 cm)



ILLUM WIKKELSØ

65

FACTS:

Furniture group
Model Vedersø
Chair, sofa
and coffee table.

Made by: C.F.Christensen



ILLUM WIKKELSØ

66

FACTS:

Side chair

Made by N.Eilersen

Dimensions

H 29.53 in. W: 22.05 in. D:
24.81 in.

H: 75 cm W: 56 cm D: 63 cm

Seat height

17.72 in. (45 cm)



ILLUM WIKKELSØ

67

FACTS:

Side chair

Made by
Mikael Laursen

Dimensions

H: 31.11 in. W: 20.08 in. D:
19.69 in.

H: 79 cm W: 51 cm, D: 50 cm

Seat height
18.12 in. (46 cm)



ILLUM WIKKELSØ

68

FACTS:

Leather Lounge Chair
Made by
Ryesberg Møbler
Model: Apollo



Dimensions

H: 31.5 in. W: 39.38 in. D: 41.34 in.

H: 80 cm W: 100 cm D: 105 cm

Seat height 16.54 in. (42 cm)



ILLUM WIKKELSØ

69

FACTS:

Easy chair
no.34

Made by
N. Eilersen 1955.



Dimensions

H: 28.35 in. W: 28.75 in. D: 28.35 in.

H: 72 cm W: 73 cm D: 72 cm

Seat height 11.82 in. (30 cm)



STOL NR. 34 - sort
flettet med flækkede
peddigrør

Tegnet af arkitekt Illum Wikkelsø

A/S N. EILERSEN . SKAMBY

Telefon Uggerslev 2 og 8

ILLUM WIKKELSØ

70

FACTS:

Rosewood desk

Made by: P. Schultz & Co.
Galten, Denmark

Dimensions

H: 28 in. W: 79 in. D: 40 in.
H: 71.12 cm W: 200.66 cm D:
101.6 cm



ILLUM WIKKELSØ

71

FACTS:

Easy chair, sofa, coffee table and footstool model Genius.

Made by
C. F. Christensen.



Dimensions

H: 30.5 in. W: 28.25 in. D: 24.5 in.
Seat height 16 in. (40.64 cm)

H: 77.47 cm W: 71.76 cm D: 62.23 cm



ILLUM WIKKELSØ

71.A

FACTS:

Coffee tables model Genius

Made by
C. F. Christensen.

Dimensions

H: 16.93 in. 41.74 in. Dm
41.74 in.

H: 43 cm, DM 106 cm



Coffee table; See no. 71.

Dimensions

H: 17.33 in. W: 29.14 in. D: 29.14 in.

H: 44 cm W: 74 cm, D: 74 cm



ILLUM WIKKELSØ

72

Trapetz coffee table. Made by Torbjorn Hansson Wood Workshop Gothenburg, Sweden 2024.

Made after original drawings. Sketch included in the drawing from 1954.

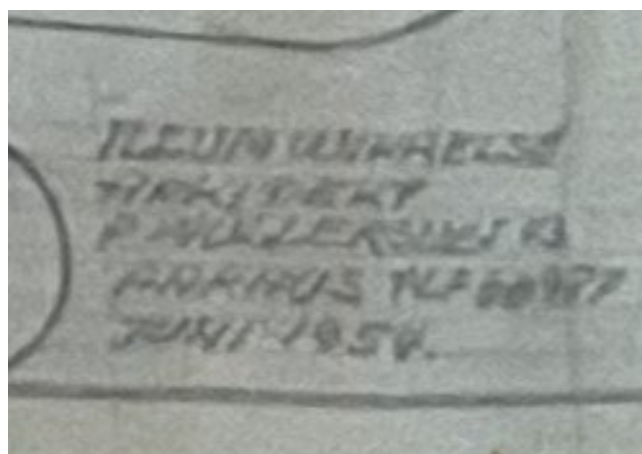
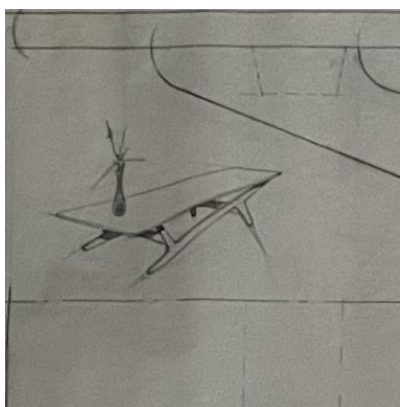

ILLUM WIKKELSØ

73

FACTS:

Easy Chair
Designs:
Nanna Ditzel & Illum
Wikkelsø

Made by Søren Villadsen

Dimensions

H: 29.14 in. W: 31.5 in. D:
27.56 in.

H: 74 cm W: 80 cm D: 70 cm
Seat height 14.97 in. (38 cm)



ILLUM WIKKELSØ

74

FACTS:

Sofa model MI-140

Made by Michael Laursen



Dimensions

H: 27.56 in. W: 88.59 in. D: 31.5 in.

H: 70 cm W: 225 cm D: 80 cm

Seat height 15.75 in. (40 cm)

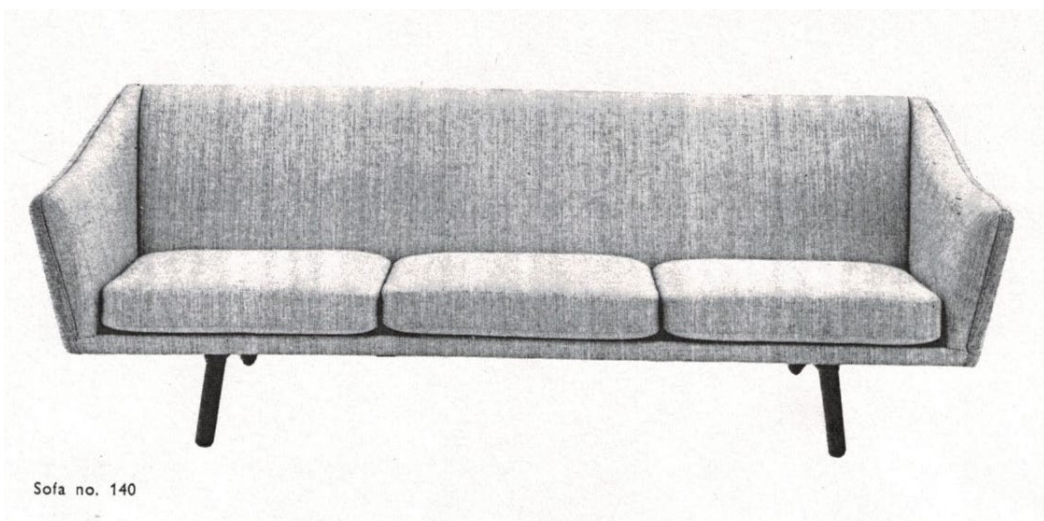

Sofa no. 140

ILLUM WIKKELSØ

74A

FACTS:

Chairs Model ML-141-142

Made by Michael Laursen



COMMENTS



ILLUM WIKKELSØ

75

FACTS:

Side chair

Made by C .F. Christensen

Dimensions

H: 30.12 in. W: 24.41 in.

D: 18.9 in.

H: 76.5 cm W: 62 cm D: 48 cm

Seat height 17.92 in.

(45.5 cm)



ILLUM WIKKELSØ

76

FACTS:

High-Backed Lounge chair
model 500

Made by
Aarhus Polstrermøbelfabrik



Dimensions

H: 37 in. W 35.5 in. D: 40 in. H: 93.98 cm W: 90.17 cm D: 101.6 cm



ILLUM WIKKELSØ

77

FACTS:

Folding Side Tables

Made by
C. F. Christensen, Silkeborg



Dimensions

H: 17 in. W: 18.75 in. D: 21 in.

H: 43.18 cm W: 47.63 cm D: 53.34 cm

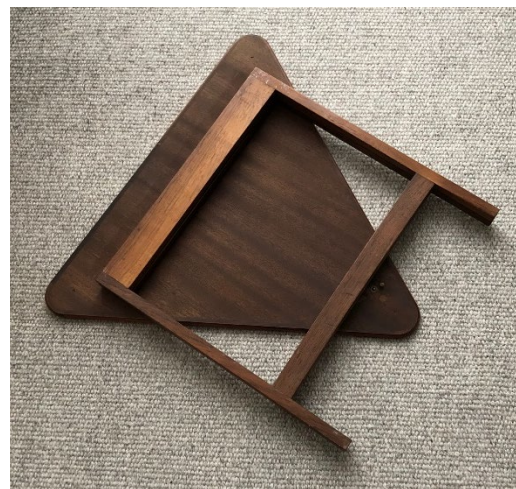

ILLUM WIKKELSØ

78

FACTS:

Glass table no.10

Made by
C. F. Christensen, Denmark.



10

glasbord
underdel massiv
glasplade 10-12 mm

glass-table KD
base solid
glass-top 10-12 mm

Glastisch, zerlegbar
Gestell massiv
Glasplatte 10-12 mm

underdel skilbar

base KD

Gestell, zerlegbar

glasplade

glass-top

Glasplatte

105 cm H: 42 cm
41½" H: 16½"

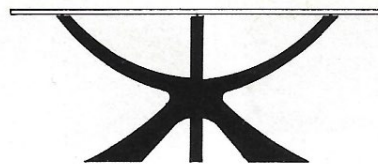

ILLUM WIKKELSØ

79

FACTS:

Side chair

Made by P. Schultz, Galten.

Dimensions

H: 31.11 in. W: 24.02 in. D:
20.08 in.

H: 79 cm W: 61 cm D: 51 cm



ILLUM WIKKELSØ

80

FACTS:

Coffee table
Model ML 115
Made by:
Mikael Laursen.



Dimensions

H: 18.75 in. W: 64.75 in. D: 26.5 in.
H: 47.63 cm W: 164.47 cm D: 67.31 cm

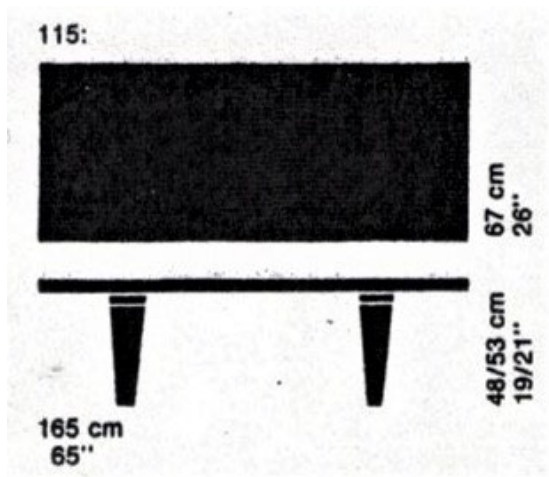

ILLUM WIKKELSØ

81

FACTS:

Resting chair and footstool.
Model ML 214

Made by Mikael Laursen.



ILLUM WIKKELSØ

82

FACTS:

CROISSANT; Sofa and lounge chair model.

Original made by
Århus Polster Møbelfabrik.

Since 2019 produced by GUBI
with exclusive, time unlimited
and irrevocable rights.



ILLUM WIKKELSØ

83

FACTS:

Swivel chair
Model ML 213

Made by Mikael Laursen



Swivel chair,
Seat height 40 or 46 cm.



Sofa table, model ML 214.



ILLUM WIKKELSØ

84

FACTS:

Folding tables

Made by
C. F. Christensen

Dimensions

H: 19.75 in. W: 23.25 in. D:
15.75 in. H: 50.17 cm W:
59.06 cm D: 40.01 cm

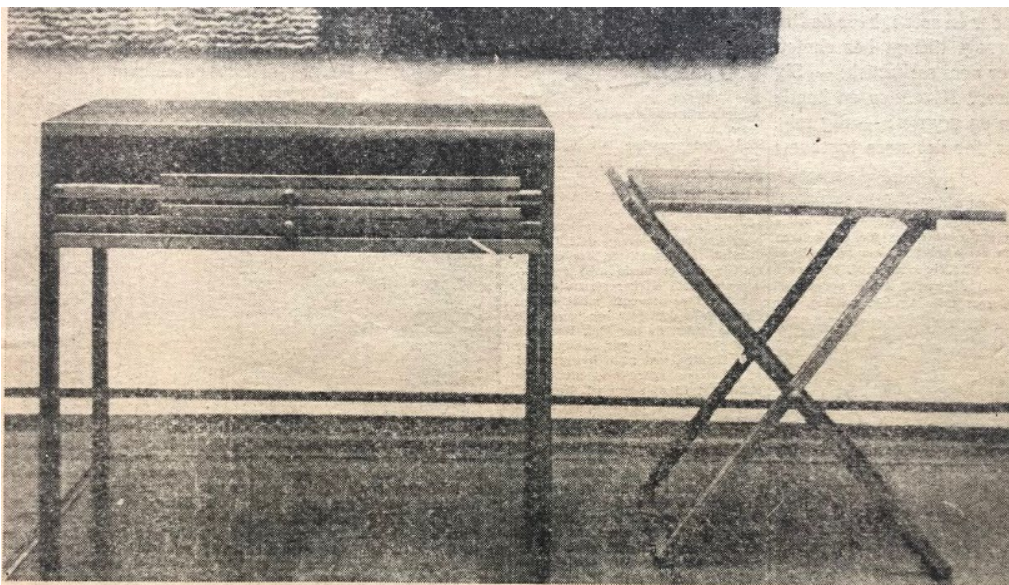

FIRE-I-EET-BORD

Den mest almindelige form for indskudsbord består af tre eller flere borde, der er skubbet ind under hinanden. Fejlen ved dette system kan være, at man ikke kan få fat

i det mellemste bord, hvis det er udstyret med sarg imellem det bageste benpar. Illum Wikkelsø har tegnet en ny type indskudsbord, hvor man kan disponere over fire

borde af forskellig højde, og man kan få fat på dem hver for sig, uden de kommer i karambolage med hinanden, fordi de tre klapborde ligger

som skuffer i det fjerde. Indskudsbordet fås i teak, palisander eller asketræ. Teakmodellen koster kr. 424,00. Set i Illums Bolighus. m. i. h.

ILLUM WIKKELSØ

85

FACTS:

Lounge Chair
Model ML90
Made by Mikael Laursen

Dimensions

H: 29.93 in. W: 29.93 in. D:
33.47 in.

H: 76 cm W: 76 cm D: 85 cm

Seat height 15.75 in. (40 cm)



ILLUM WIKKELSØ

86

FACTS:

Chairs
model: RY, also named Turnus

Made by
C. F. Christensen in 1975

Made in oak, beech and pine.



ILLUM WIKKELSØ

87

Sofa and lounge chair
Model: Lotus V.26

Made by
Holger Christiansen
1981



Address, see page 5
Adresse, sehen Sie Seite 5
Adresse, voir page 5

Design: Illum Wikkelsø.
Sofa V.26, 2 seats, leather, synthetic down cushions, rosewood legs.
Size: W. 1.34 m. D. 0.67 m. H. 0.75 m.

Chair V.26, leather, synthetic down cushions, rosewood legs.
Size: W. 0.76 m. D. 0.67 m. H. 0.75 m.

Table V.26, leather top, rosewood.
Size:
W. 1.10 m. D. 0.60 m. H. 0.50 m.
W. 0.55 m. D. 0.55 m. H. 0.30 m.

Design: Illum Wikkelsø.
Sofa V.26, 2-sitzig, Leder, Polydaunenkissen, Füsse Palisander.
Größe:
Br. 1,34 m. T. 0,67 m. H. 0,75 m.

Sessel V.26, Leder, Polydaunenkissen, Füsse Palisander.
Größe:
Br. 0,76 m. T. 0,67 m. H. 0,75 m.

Tisch V.26, Platte Leder, Palisander.
Größen:
L. 1,10 m. Br. 0,60 m. H. 0,50 m.
L. 0,55 m. Br. 0,55 m. H. 0,30 m.

Dessin: Illum Wikkelsø.
Canapé V.26 pour 2 perses avec coussins cuir garnis de duvet. Pieds en palissandre.
Dimensions:
L. 1,34 m, L. 0,67 m, H. 0,75 m

Siège V.26 avec coussins cuir garnis de poly-duvet. Pieds en palissandre.
Dimensions: L. 0,76 m, L. 0,67 m, H. 0,75 m.

Table V.26 avec plateau cuir lissandre.
Dimensions:
L. 1,10 m, L. 0,60 m, H. 0,50 m.
L. 0,55 m, L. 0,55 m, H. 0,30 m.



ILLUM WIKKELSØ

88

FACTS:

Sofa and lounge chair.

Model: V.11A

Made by

Holger Christiansen



Model V 11 A. Sofa available for 2 and 3 persons. With buff upholstery, down cushions and legs in Brazilian rosewood. Maximum external dimensions: 2 persons: width 1.57 m, depth 0.78 m, height 0.68 m. 3 persons: width 2.20 m, depth 0.78 m, height 0.68 m.

Chair with same upholstery and cushions as sofas. Maximum external dimensions: width 0.85 m, depth 0.78 m, height 0.68 m.



ILLUM WIKKELSØ

89

FACTS:

Sofa and chairs
Model: V.3A

Made by
Holger Christiansen



ILLUM WIKKELSØ

90

FACTS:

Sofa and chair
Model: V.13.

Made by
Holger Christiansen



ILLUM WIKKELSØ

91

FACTS:

Chairs, sofa and table
Model: Simplex

Made by
Brdr. Andersens
Møbelsnedkeri



ILLUM WIKKELSØ

92

FACTS:

Tables

Made by
Brdr. Andersens
Møbelsnedkeri in 1980.

Made in modules with the
same "legs" and 15 different
combinations.

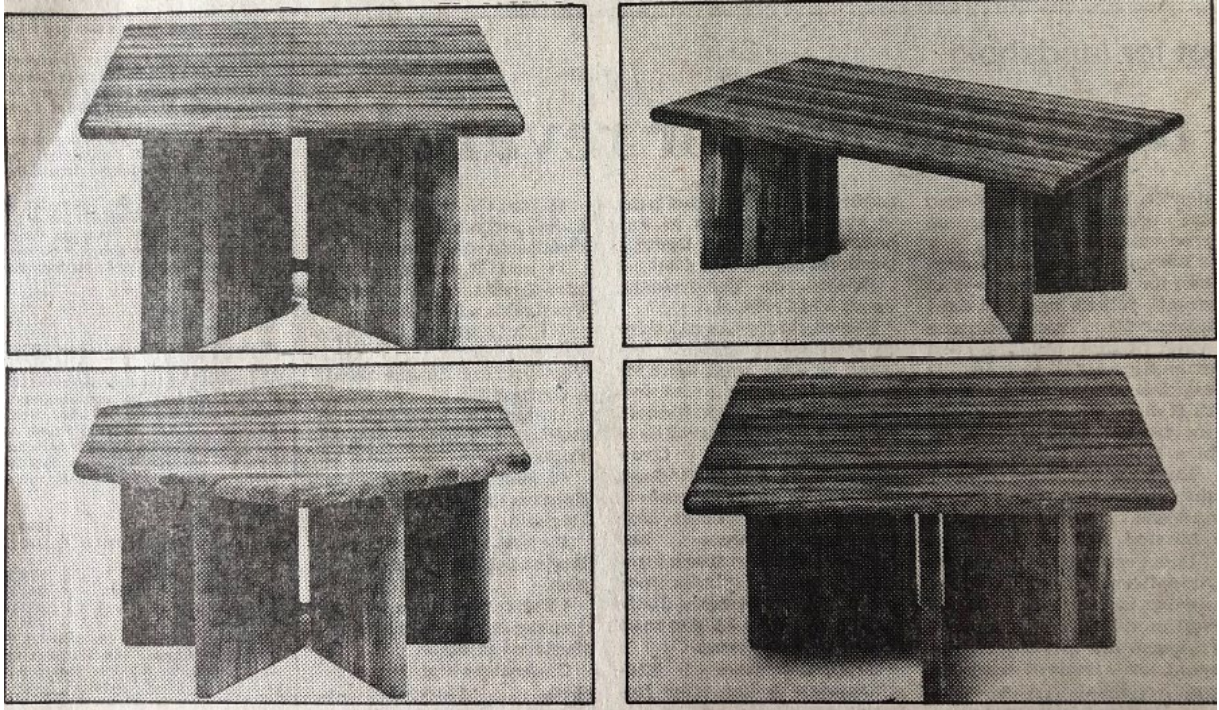

ILLUM WIKKELSØ

93

FACTS:

Bookshelf
Model: Apollo

Made by: Siex møbler

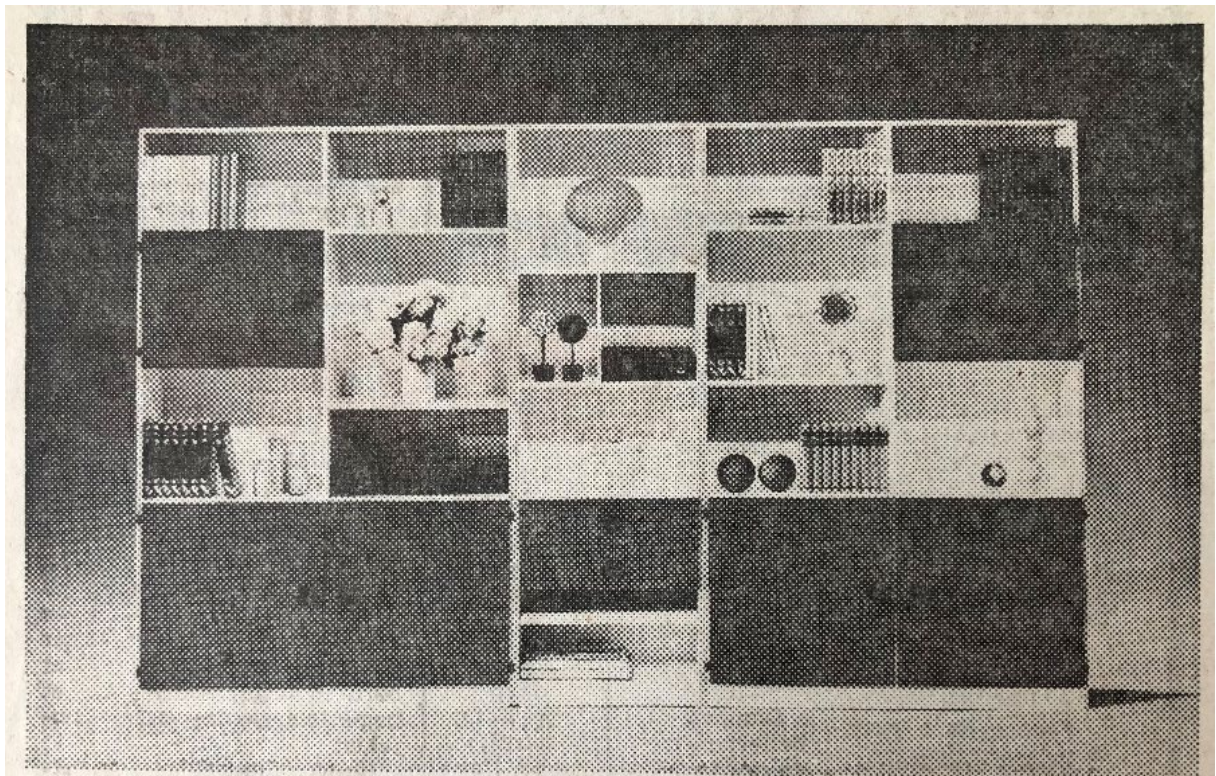

En virkelig byggereol

Illum Wikkelsø har for Siex-møbler tegnet en reol med indbygget aluminiumsskinne i forkanten, således at man selv kan bygge til efter behov. Låger, skuffer m. v. kan købes som løsdels.

SIEX

ILLUM WIKKELSØ

94

FACTS:

Sofa
model V25

Made by:
Holger Christiansen

3 seated: H: 86 cm, W: 209
cm, D: 75 cm
2 seated: H: 86 cm, W 142
cm, D: 75 cm

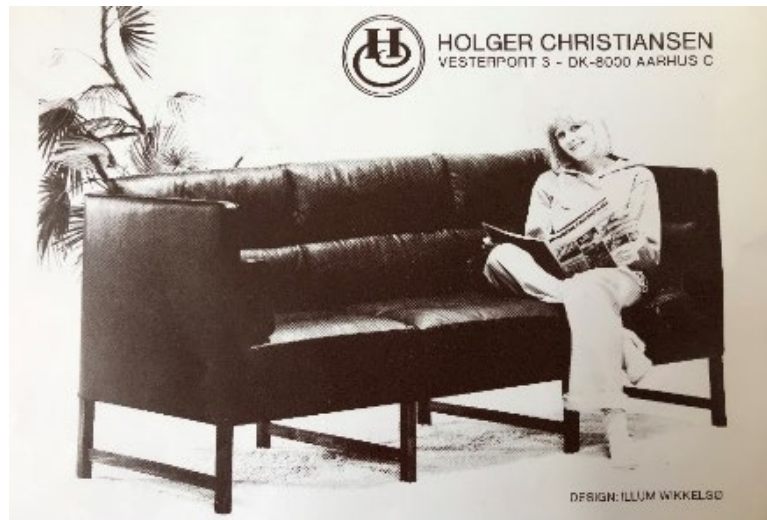

ILLUM WIKKELSØ

95

FACTS:

Sofa and chair
model V.24
Made by:
Holger Christiansen

Sofa 2 seated: H: 78 cm, W:
126 cm, D: x80 cm

Lounge chair: H: 78 cm, W: 67
cm, D: 85 cm

High back chair:
H: 101 cm, W: 67 cm,
D: 85 cm



ILLUM WIKKELSØ

96

FACTS:

Chair and sofa

Made by
Mikael Laursen 1973

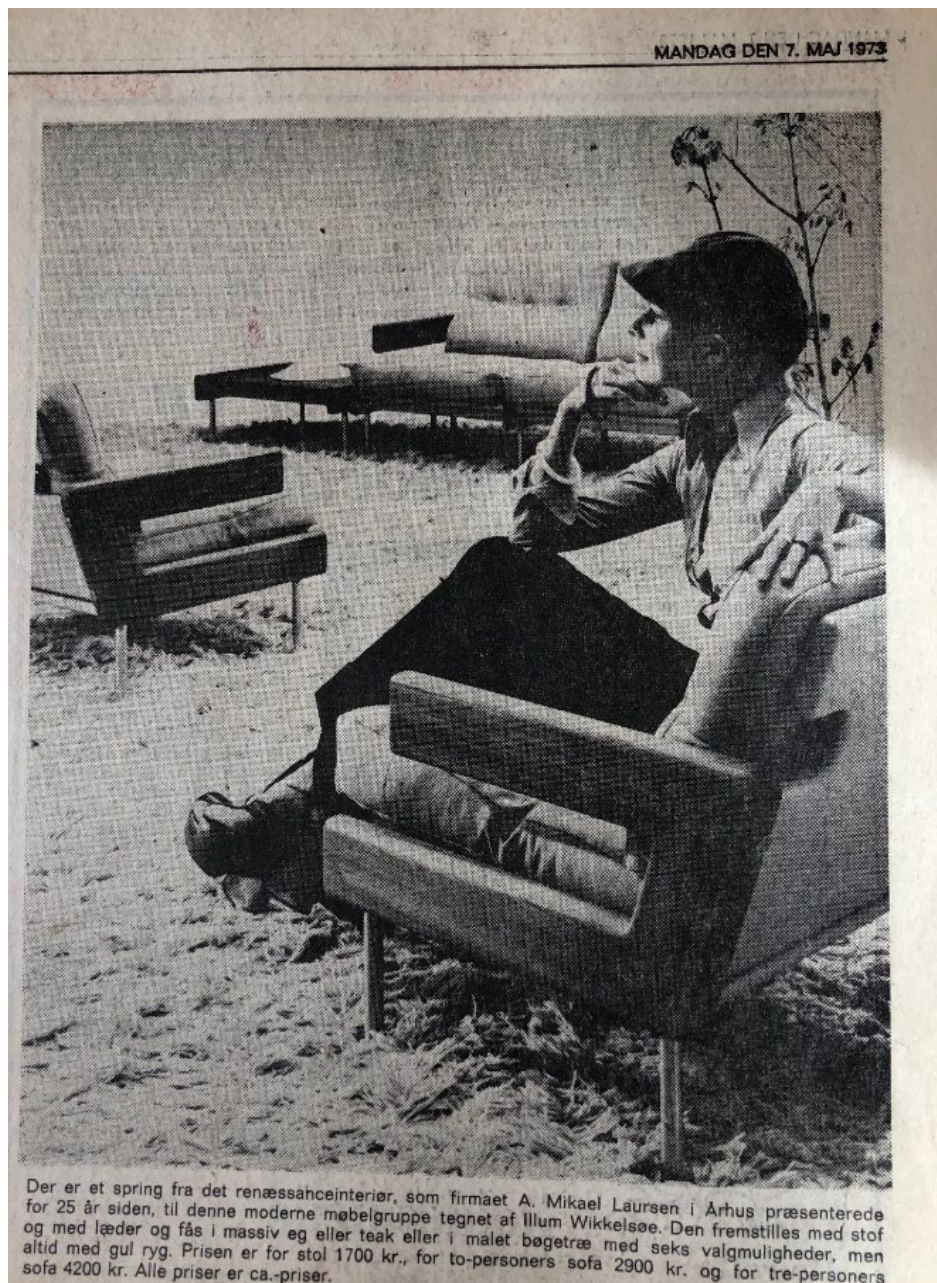

FACTS:

Furniture group,
Model Telius
Made by
C. F. Christensen 1976

SØNDAG DEN 4. APRIL 1976

MORGEN
Jylland



Polstret siddegruppe i egetræ.

Kønne og solide fyrretræs- møbler til sommerhuset

**Polstrerede
møbler, der
er beregnet
til at
slappe af i**

så bordets længde kan blive 2,20 meter. Prisen (den vejledende) er lidt under 2000 kroner. Ligeledes massive og enkle fyrretræsstole med højere eller lavere ryg koster fra ca. 350 kroner til ca. 370 kroner. Et andet bord er forsynet med to klapper— hver 60 cm lange — samme længde som den faste del af bordet, der samtidig er en meter bredt. Det giver 1,80 cm bord for ca. 1600 kroner. Et

en hvile- og hyggegruppe er absolut ikke overflødig i fritidshuset. En billig og alt andet end kedelig løsning er stålmebelserien Senator fra Homa. Møblerne er fremstillet af 70 mm rektangulære stålrør og er plastbehandlet med en mat, sort finish, som giver en smuk overflade. Hynderne er bestruktet med finsk bomuldsstof i en stor tern, der passer til linjerne i møblerne. Prisen for

en hel møbelgruppe omfattende 3-personers sofa, to-personers sofa, stol og bord vil være ca. 2500 kroner.

I en anden, mere eksklusiv klasse er serien Tellus fra C. F. Christensen A/S og tegnet af Illum Wikkelsø. Prisen for en tre-personers sofa i denne serie er ca. 5000 kroner (med udvalgt stof), for en to-personers ca. 3500 kroner, for armstol ca. 1800 kr. Sofabordet koster ca.

ILLUM WIKKELSØ

98

FACTS:

Easy chair

Unknown Producer



Kommer han dog ikke snart . . . hvorfor ringer han ikke? Jo, denne situation er vel uforanderlig gammelkendt . . . uanset at stolene er meget moderne. De er tegnet af arkitekt Illum Wikkelsø. På væggen et maleri af Stig Fogtdal.

ILLUM WIKKELSØ

99

FACTS:

Chair
Leather and steel

Made by Holger Christiansen



ILLUM WIKKELSØ

100

FACTS:

Furniture group

Made by
Søren Willadsen, Vejen

The designer

Illum Wikkelsø is sitting in
his own chair at the photo.



Arkitekt Wikkelsø i en af sine egne, nye stole.

Den nye møbel-serie i forskellige opstillinger.



INTERESSANT NY MØBEL-SERIE

Den århusianske møbelarkitekt Illum Wikkelsø har på ny gjort sig bemærket. Denne gang med en interessant møbel-serie, der er fremkommet både i lakeret udførelse og i teak.

Serien er bygget op over et taburetstel, og som man ser på billederne, giver det mange anvendelsesmuligheder.

Man kan bruge stellet med plade til bord, og man kan lægge en ekstra plade over, så man får et højere bord. Man kan lægge en pude på, og man kan sætte et helt stole-element på.

Det nye sæt vistes for første gang på den internationale messe i Frankfurt i slutningen af august i år, før det kom frem herhjemme. Det skyldes, at det tyske marked i dag er det største for dansk møbel eksport. Det har endda oversteget det amerikanske, det

ILLUM WIKKELSØ

101

FACTS:

Furniture group
Model Campus

Made by C.F.Christensen
1970



See also next page. 101.A.



ILLUM WIKKELSØ

101 A

FACTS:

Furniture group
Model Campus
Made by C. F. Christensen
1970

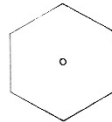

700

taburet, adskillelig
træ lamineret
puder granuleret
polyether
på gummigjorde

stool KD
wood laminated
cushion granulated
polyether
on rubber straps

Hocker, zerlegbar
Holz laminiert
Kissen Polyether
granuliert
auf Gummigurten

60 x 60 cm H: 32 cm
23½" x 23½" H: 12½"

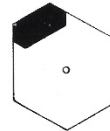

701

stol med 1 lav ryg,
adskillelig
træ lamineret
puder granuleret
polyether
på gummigjorde

chair with 1 low back
KD, wood laminated
cushions granulated
polyether
on rubber straps

Sessel mit 1 niedrigen
Rücken, zerlegbar
Holz laminiert
Kissen Polyether
granuliert
auf Gummigurten

60 x 60 cm H: 64 cm
23½" x 23½" H: 25"



702

stol med 2 lave rygge,
adskillelig
træ lamineret
puder granuleret
Polyether
på gummigjorde

chair with 2 low backs
KD, wood laminated
cushions granulated
polyether
on rubber straps

Sessel mit 2 niedrigen
Rücken, zerlegbar
Holz laminiert
Kissen Polyether
granuliert
auf Gummigurten

60 x 60 cm H: 64 cm
23½" x 23½" H: 25"



703

stol med 3 lave rygge,
adskillelig
træ lamineret
puder granuleret
polyether
på gummigjorde

chair with 3 low backs
KD, wood laminated
cushions granulated
polyether
on rubber straps

Sessel mit 3 niedrigen
Rücken, zerlegbar
Holz laminiert
Kissen Polyether
granuliert
auf Gummigurten

60 x 60 cm H: 64 cm
23½" x 23½" H: 25"



706

stol med 2 lave og 1 høj
ryg, adskillelig
træ lamineret
puder granuleret
polyether
på gummigjorde

chair with 2 low and
1 high back KD
wood laminated
cushions granulated
polyether
on rubber straps

Sessel mit 2 niedrigen
und 1 hohen Rücken,
zerlegbar
Holz laminiert
Kissen Polyether
granuliert
auf Gummigurten

60 x 60 cm H: 98 cm
23½" x 23½" H: 38½"



711

bord, adskilleligt
træ lamineret

table KD
wood laminiert

Tisch, zerlegbar
Holz laminiert

60 x 60 cm H: 32 cm
23½" x 23½" H: 12½"



712

lampebord, adskilleligt
træ lamineret
lampeskærm acryl

lamp table KD
wood laminated
lamp-top acryl

Lampentisch, zerlegbar
Holz laminiert
Lampenschirm Acryl

60 x 60 cm H: 40 cm
23½" x 23½" H: 16"

ILLUM WIKKELSØ

102

FACTS:

Furniture group

Made by Holger Christiansen

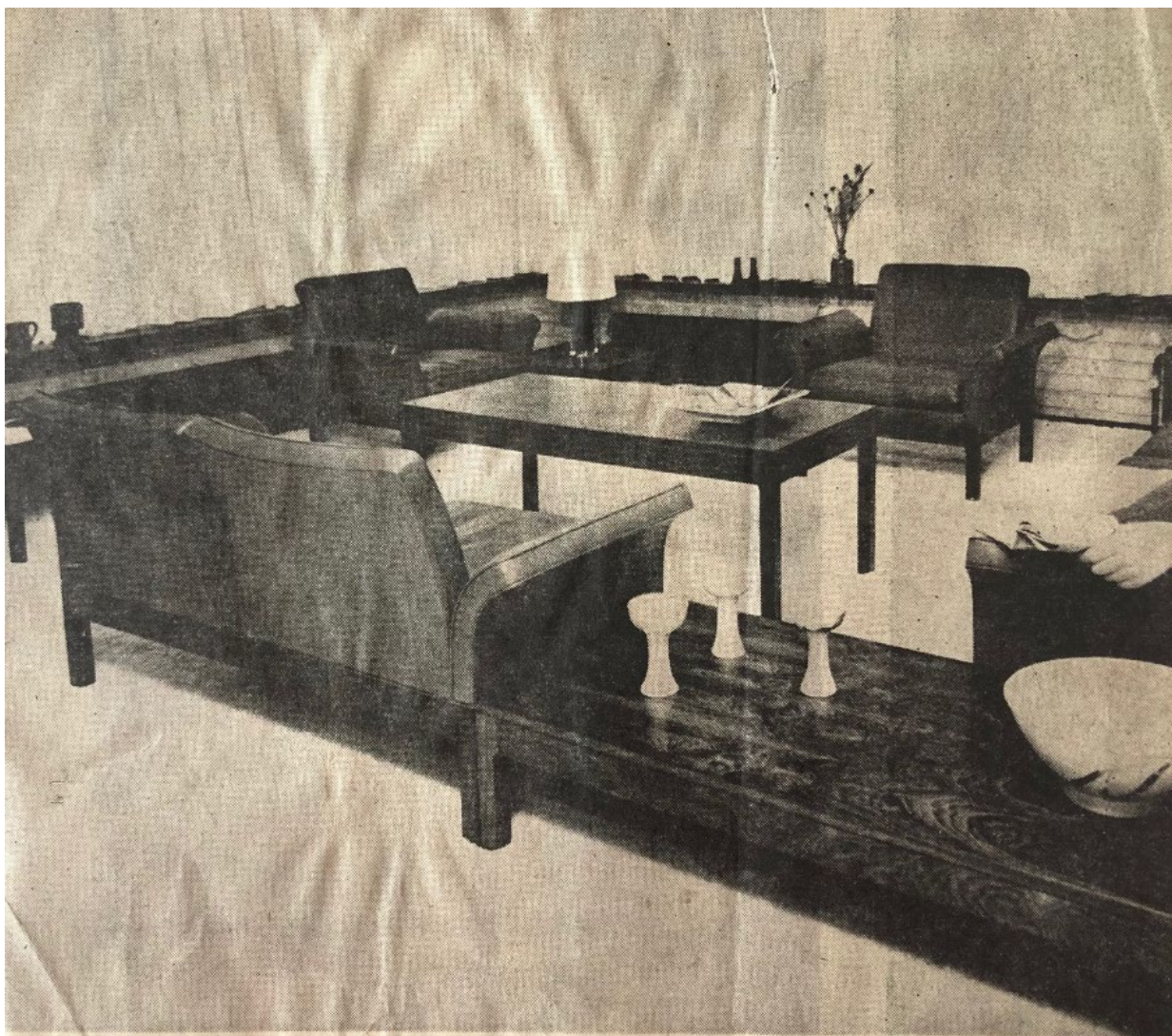

eder og palisander kan også virke let og fleksibelt som i denne møbelgruppe med to- og tre-personers sofa og en stol i normal bordhøjde. Illum Wikkelsø har tegnet dem for Holger Christiansen, og priserne er: sofa 3.500 kr., stol 2220 kr., bord 58×123 cm 630 kr. og det samme bord i 30 cms højde godt 600 kr.,

ILLUM WIKKELSØ

103

FACTS:

Furniture group
Model: Discus

Chair, sofa
and coffee table.

Made by: C. F. Christensen



COMMENTS

DISCUS, modular system. Discus is made from black oak (laminated wood). Polyfill-cushions on rubber-webbing covered in fabric or leather. The Discus-range includes: easy-chair, sofas and tables.

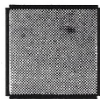

811

bord, adskilleligt
underdel lamineret
bordplade fineret

table KD
base laminated
top veneer

Tisch, zerlegbar
Gestell laminiert
Platte furniert

58 x 58 cm H: 40 cm
23" x 23" H: 16"

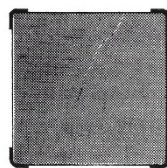

812

bord, adskilleligt
underdel lamineret
bordplade fineret

table KD
base laminated
top veneer

Tisch, zerlegbar
Gestell laminiert
Platte furniert

102 x 102 cm H: 44 cm
40" x 40" H: 17½"

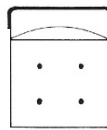

801

lav stol uden arme,
adskillelig
træ lamineret
puder polyfill
på gummigjorde

low chair no arms KD
wood laminated
cushions polyfill
on rubber straps

Niedriger Sessel ohne
Armlehnen, zerlegbar
Holz laminiert
Kissen Polyfill
auf Gummigurten

35 x 74 cm H: 65 cm
25½" x 29" H: 25½"

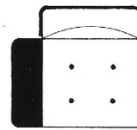

802

lav stol med 1 arm,
adskillelig
træ lamineret
puder polyfill
på gummigjorde

low chair with 1 arm KD
wood laminated
cushions polyfill
on rubber straps

Niedriger Sessel mit
einer Armlehne,
zerlegbar
Holz laminiert
Kissen Polyfill
auf Gummigurten

82 x 74 cm H: 65 cm
32" x 29" H: 25½"

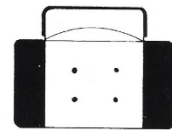

803

lav stol med 2 arme
adskillelig
træ lamineret
puder polyfill
på gummigjorde

low chair with 2 arms
KD, wood laminated
cushions polyfill
on rubber straps

Niedriger Sessel mit 2
Armlehnen, zerlegbar
Holz laminiert
Kissen Polyfill
auf Gummigurten

98 x 74 cm H: 65 cm
38½" x 29" H: 25½"

ILLUM WIKKELSØ

104

FACTS:

Furniture group

Made by
Holger Christiansen



Der er forskellige kombinationsmuligheder med den nye, eksklusive hvilegruppe i palisander og vildthud, som Illum Wikkelsø har lavet for Holger Christiansen, Århus.

ILLUM WIKKELSØ

105

FACTS:

Chair model ML 272

Sofa model ML 270

Made by

Mikael Laursen

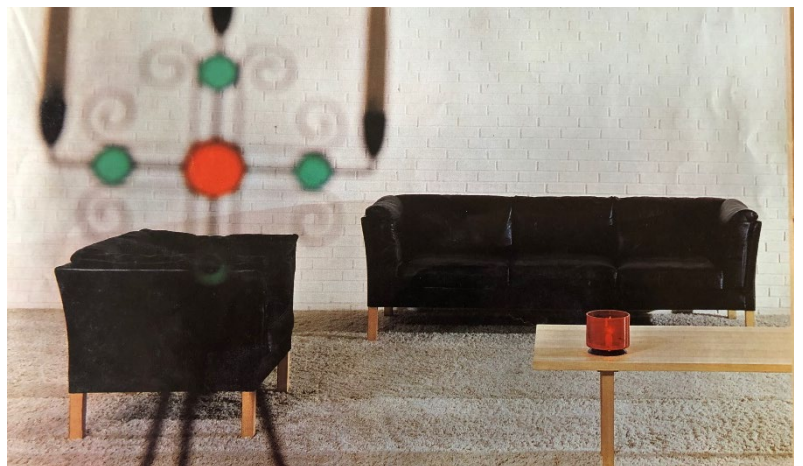

ILLUM WIKKELSØ

106

FACTS:

Chair model ML 221
Sofa model ML 220

Made by
Mikael Laursen



ILLUM WIKKELSØ

107

FACTS:

Lounge chair and sofa

Made by
Holger Christiansen.

Dimensions chair

H: 25 in. W: 39 in. D: 32 in.
H: 63.5 cm W: 99.06 cm D:
81.28 cm
Seat height 16 in. (40.64 cm)

Dimensions sofa

H: 25 in. W: 62 in. D: 36 in.
H: 63.5 cm W: 157.48 cm D:
91.44 cm
Seat height 16 in. (40.64 cm)



ILLUM WIKKELSØ

108

FACTS:

Sofa and easy chair
Model ML 80 and ML 82

Made by
Mikael Laursen

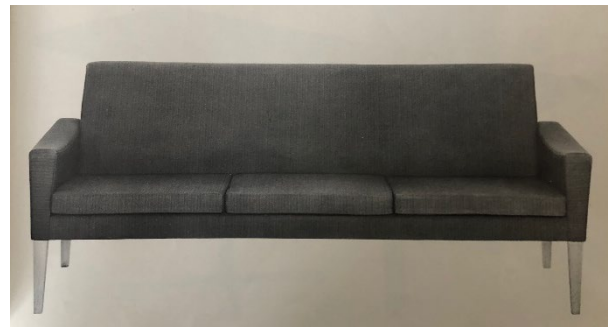

ILLUM WIKKELSØ

109

FACTS:

Sofa and armchair
Model ML 130-4, 131 and 132

Made by
Mikael Laursen



Lounge chair ML 132
High back chair 131
and sofa ML 130-3
Model 130-4 a four-
seated sofa



ILLUM WIKKELSØ

110

FACTS:

Sofa and lounge chair
Model ML 160 and ML 162

Made by
Mikael Laursen



ILLUM WIKKELSØ

111

FACTS:

Sofa, high back and lounge
chair
Model: ML 240 - 241- ML 242

Made by
Mikael Laursen



ILLUM WIKKELSØ

112

FACTS:

High back chair and footstool
Model: ML 94

Made by
Mikael Laursen



ILLUM WIKKELSØ

113

FACTS:

Sofa tables
ML 109 and ML 133

Made by
Mikael Laursen

ML 109: H: 46/53 cm, W: 164
cm, D: 63 cm

ML 133: H: 46/53 cm, DM:
125 cm



ILLUM WIKKELSØ

113A

FACTS:

Sofa tables
ML 106-110-131-132
Made by
Mikael Laursen



COMMENTS

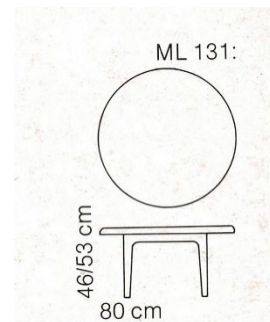
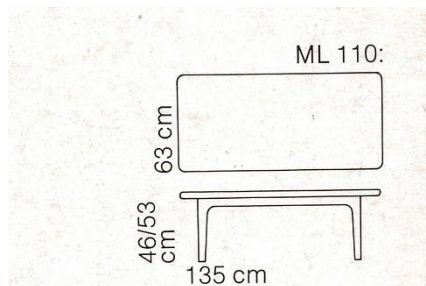
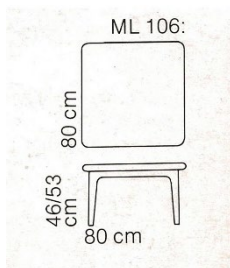

ML 132:
100 cm

ML 106/110/131/132

ILLUM WIKKELSØ

113B

FACTS:

Sofa tables
ML 163-164-165

Made by
Mikael Laursen



COMMENTS

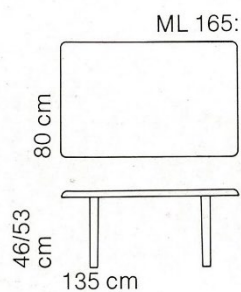
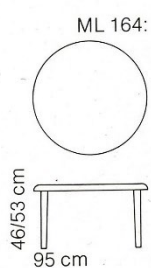
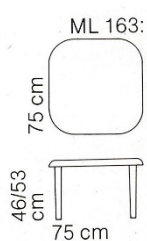

ML 163/164/165

ILLUM WIKKELSØ

113C

FACTS:

Sofa tables
ML 175-177-275

Made by
Mikael Laursen



COMMENTS

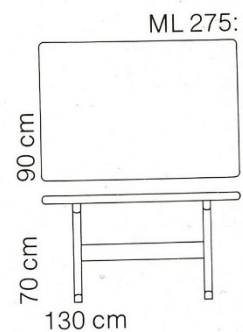
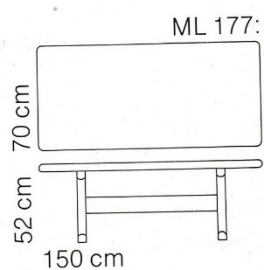
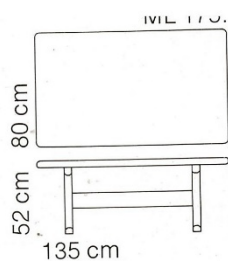

ML 175/177/275

ILLUM WIKKELSØ

113D

FACTS:

Sofa tables
ML 146 and 148
Made by
Mikael Laursen



COMMENTS

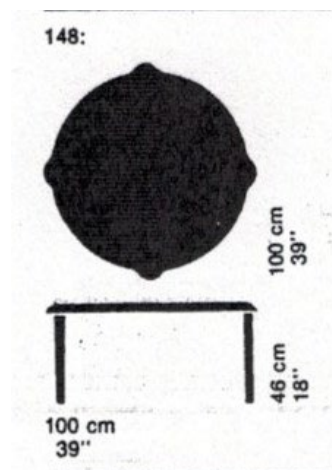
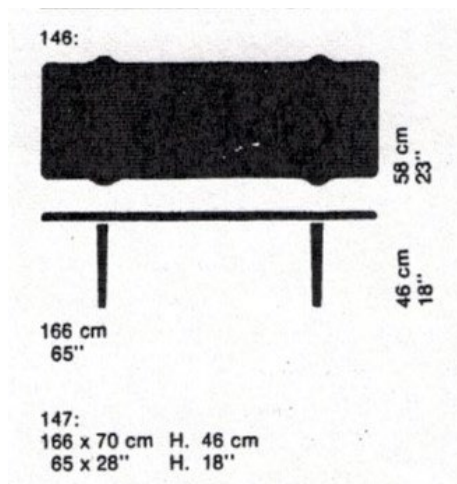

ILLUM WIKKELSØ

113E

FACTS:

Coffee table
Model ML 188 and 197
made by Mikael Laursen

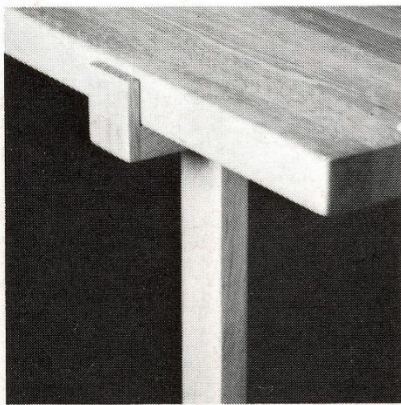

Also:
ML 186:
165x67x40/48 cm

ML187:
200x75x40/48cm.

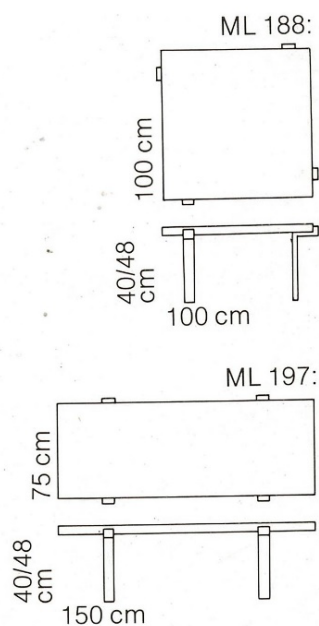

These two uncomplicated and robust coffee tables are made of 40 mm thick staves of oak or teak. They are both available with legs of steel or wood. When made of wood the legs are dimensioned in accordance with the material.

ML 188/197

ILLUM WIKKELSØ

113F

FACTS:

Coffee table
Model ML 205-
203-207-208-210
made by Mikael Laursen



COMMENTS

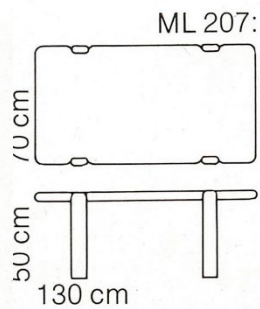
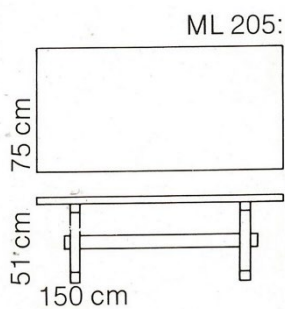

ML 203:
70 × 70 cm

ML 208:
150 × 70 cm

ML 210:
140 × 82 cm

ML 205
ML 203/207/208/210

Modern simplicity and solid nature characterize these coffee tables. The thickness of the table tops is 40 mm, and they are made of glued-together staves of teak or oak.

ILLUM WIKKELSØ

113G

FACTS:

Coffee table
Model ML 204-206-209
made by Mikael Laursen

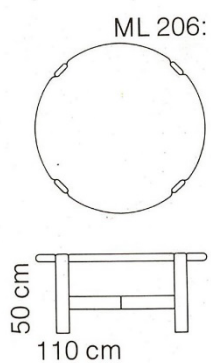
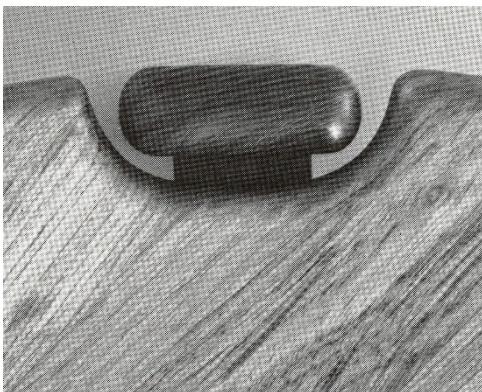

ML 209:
120 cm

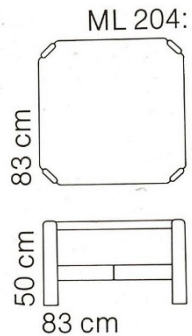

These coffee tables were designed to hail a handicraft on a high technical level. They are made of teak or oak, and the table tops are made of glued-together staves 40 mm thick.

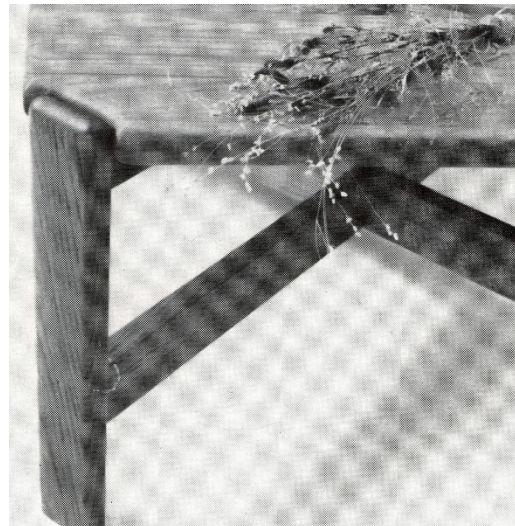

ML 204/206/209

ILLUM WIKKELSØ

113H

FACTS:

Coffee table
Model ML 525
made by Mikael Laursen



ML 525:

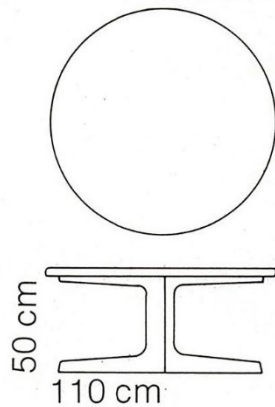

Glued-together staves 21 mm thick form the table top. Available in teak or oak.

ILLUM WIKKELSØ

113.I

FACTS:

Sofa tables
ML 116 and ML 114
Made by
Mikael Laursen



ILLUM WIKKELSØ

114

FACTS:

Lounge chair
Model V16
Made by
Holger Christiansen



ILLUM WIKKELSØ

115

FACTS:

Dinning chair with three legs.
Made 1955



„Kongelig dansk træ“

I det prøvemøblerede hus i Tre-

tommerparken, Risskov, er spise-

stuen møbleret med dekorative tre-

benede stole, tegnet af arkitekt
Illum Wikkelsø. I denne model har
amerikanerne set idealet af en dansk
spisestuestol, og den har opnaaet
store eksportordrer. For at glæde
kunderne fortæller stolens ameri-
kanske forhandlere, at stolene er
lavet af „kongelig dansk eg“ eller
„kongelig dansk bøg“.



This is a print of the original drawing
made in 1955.

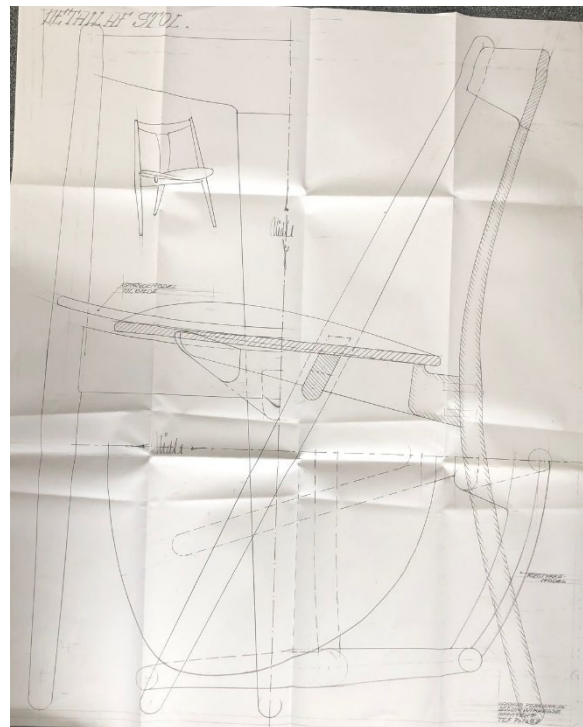

ILLUM WIKKELSØ

116

FACTS:

Furniture group
Made by Søren Villadsen.



ILLUM WIKKELSØ

117

Lounge chair
sofa and
coffee table

Made by Søren
Willadsen, Vejen,
Denmark



Probably from 1954,
when publicised in the Danish
journal "Bygge og Bo"
number 3.

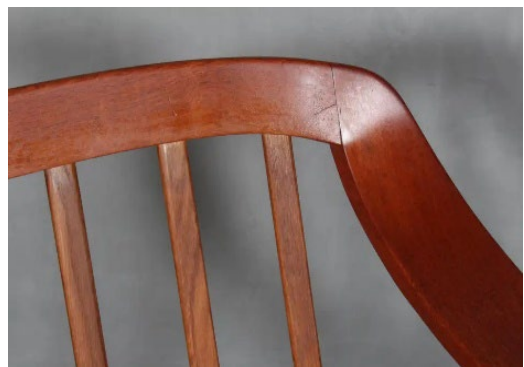
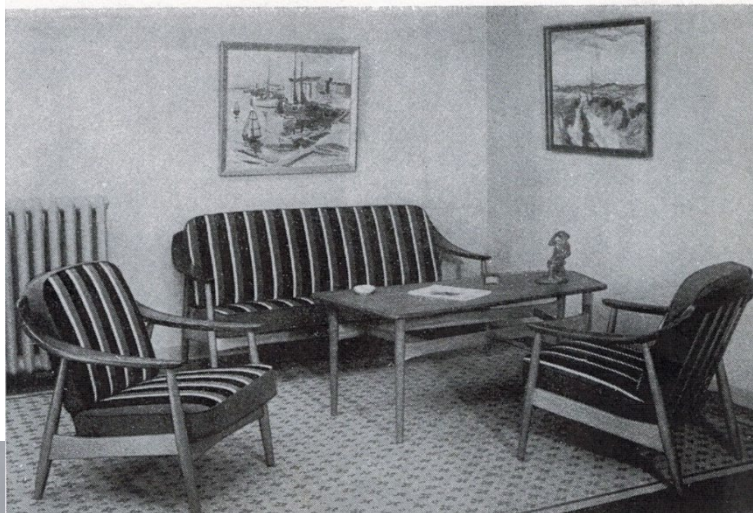

ILLUM WIKKELSØ

118

Braided pipes chair designed when Illum was employed by LEM's housing store in Aarhus

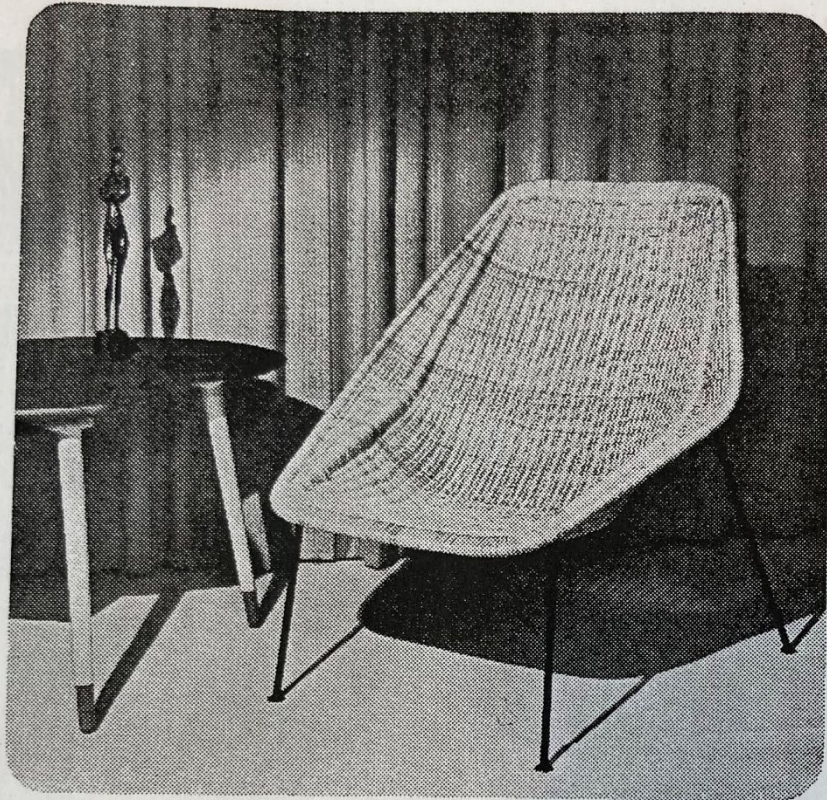

Peddigrørsstol tegnet af Illum Wikkelsø Kr. 250.00



RYESGADE 9'

Bolighus ÅRHUS 2905 - 2985

ILLUM WIKKELSØ

119

Lounge chair and
sofa
Model WIKI

Made by: Kofoed
Furniture factory
Hornslet, Denmark.



ILLUM WIKKELSØ

120

FACTS:

Furniture group

Made by
C.F.Christensen.

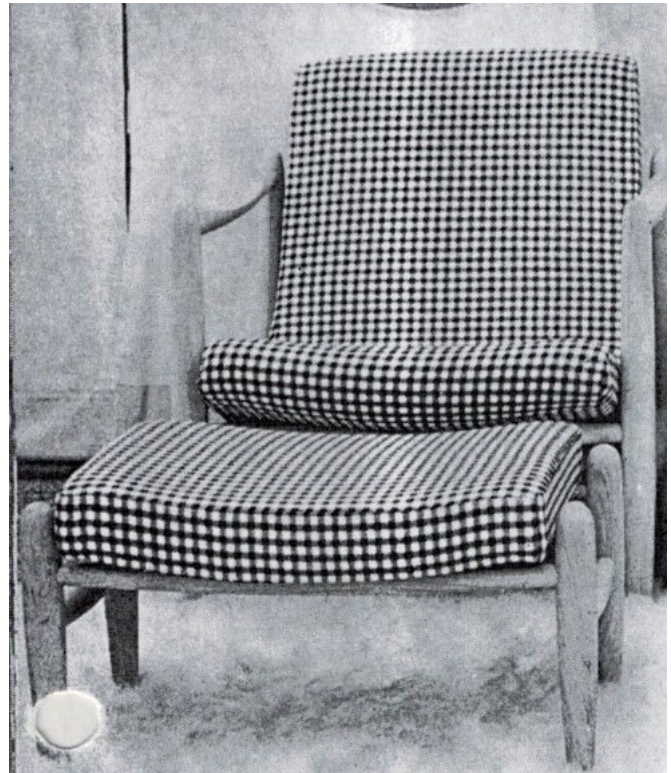

Mobile nr. 121 August- September 1965.

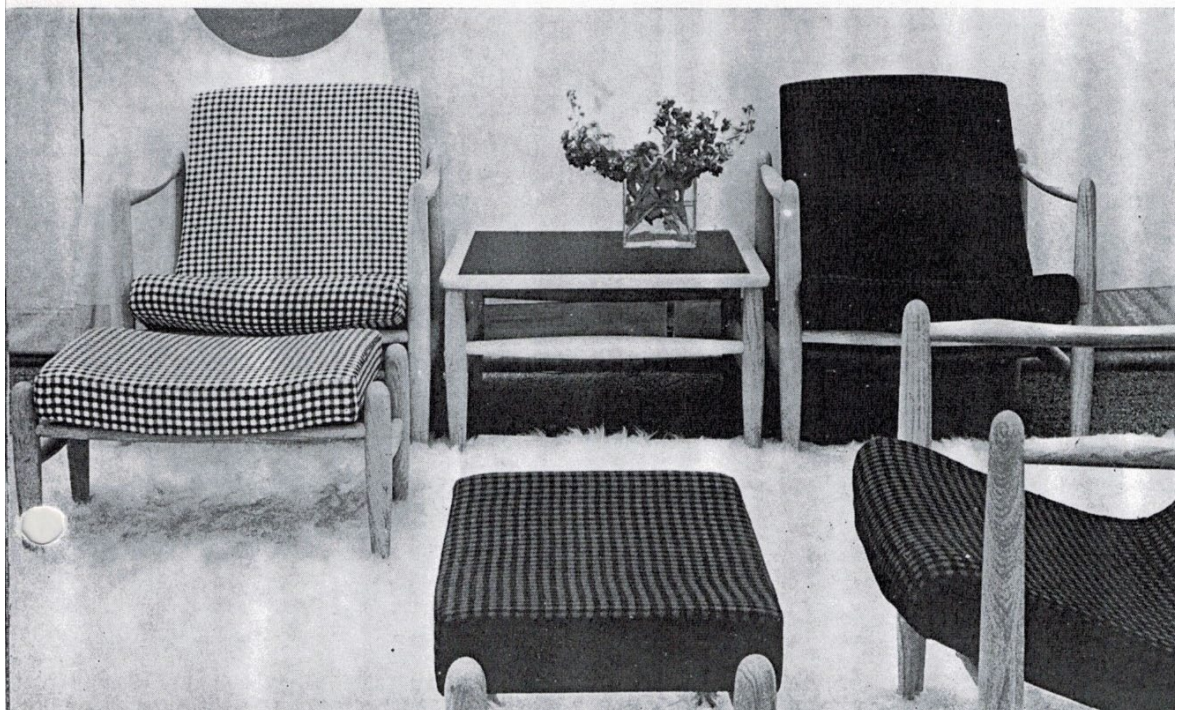

ILLUM WIKKELSØ

121

FACTS:

Nesting tables

Made by
C. F. Christensen.



Mobile number 121, August - September 1965.



ILLUM WIKKELSØ

122

FACTS:

Easy chair
model no. 190

Made by
Farstrup Savværk &
Stolefabrik.

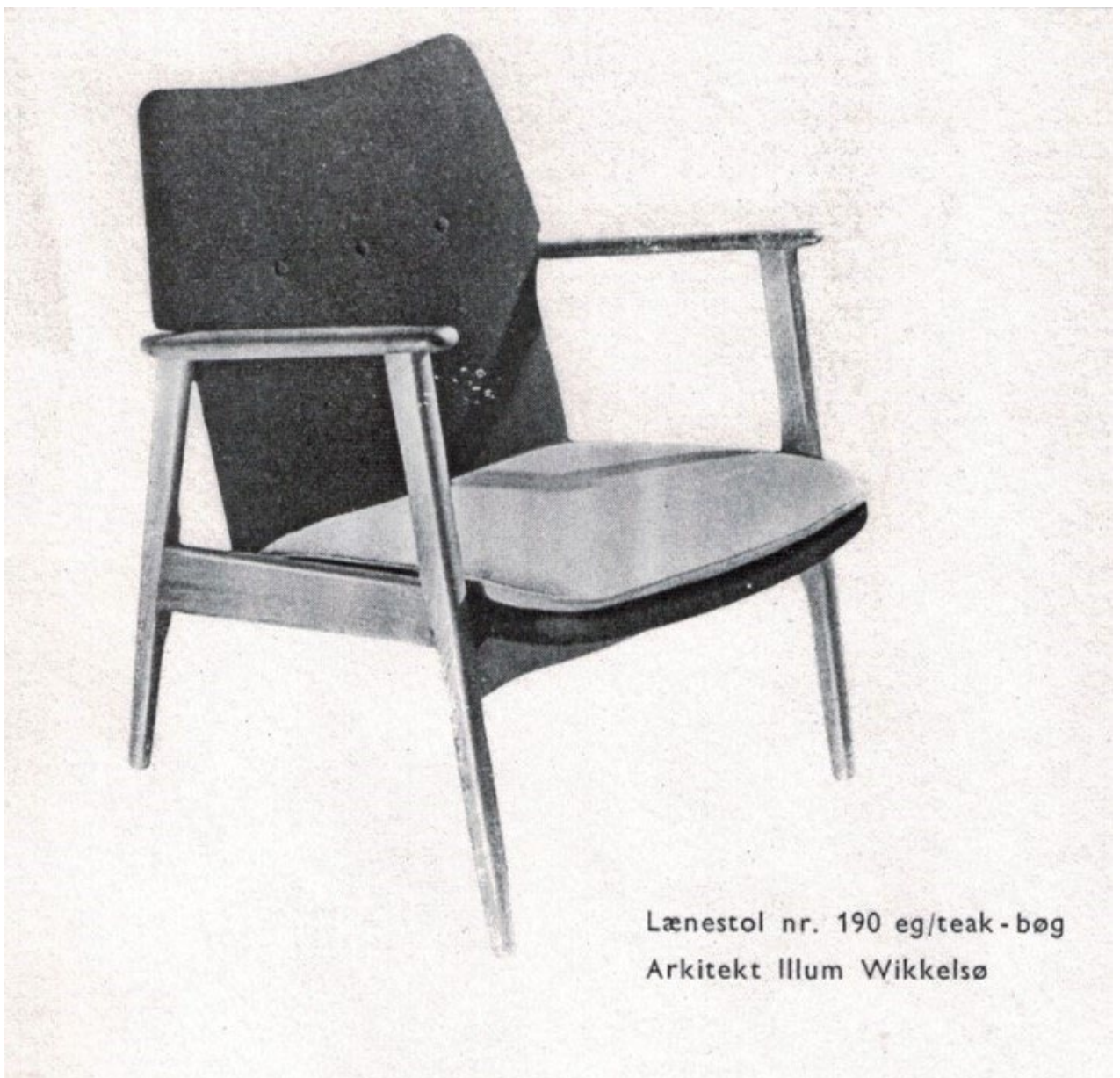

Lænestol nr. 190 eg/teak - bøg
Arkitekt Illum Wikkelsø

ILLUM WIKKELSØ

123

FACTS:

Furniture group
Model V20.

Made by
Holger Christiansen.



ILLUM WIKKELSØ

124

FACTS:

High back chair
Model V21.

Made by
Holger Christiansen.



Model V 21. High comfy-chair with leather upholstery, fibrefill-cushions and legs in Brazilian rosewood. Maximum external dimensions: width 0.82 m, depth 0.82 m, height 1.03 m.



ILLUM WIKKELSØ

125

FACTS:

Furniture group

Made by
Michael Laursen



ML 380 / 580 / 1580, see also next page 125A and B



ILLUM WIKKELSØ

125A

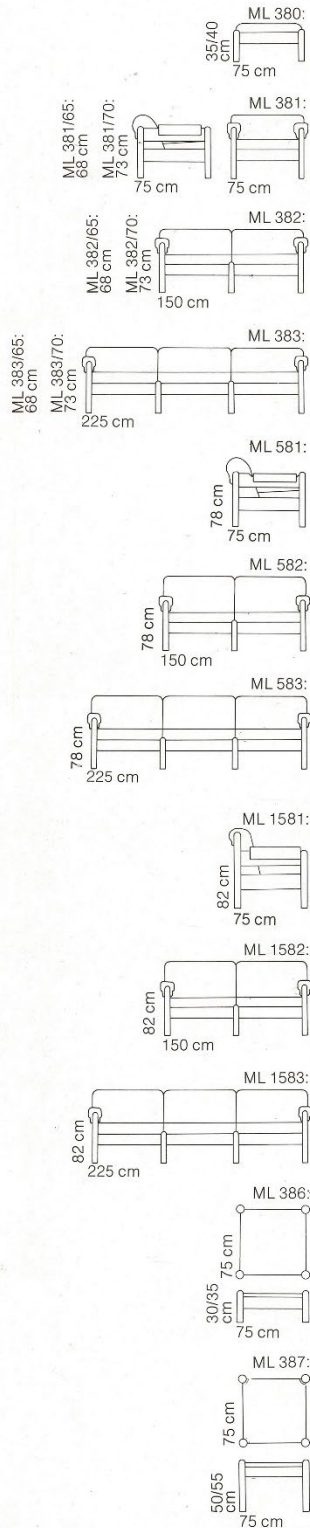

ILLUM WIKKELSØ

125B

Easy chair and
coffee table
ML 520

Made by
Michael Laursen

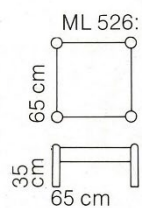
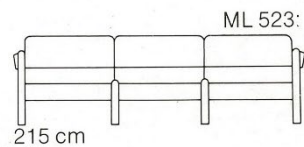
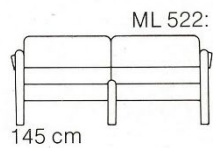
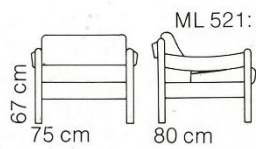
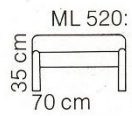
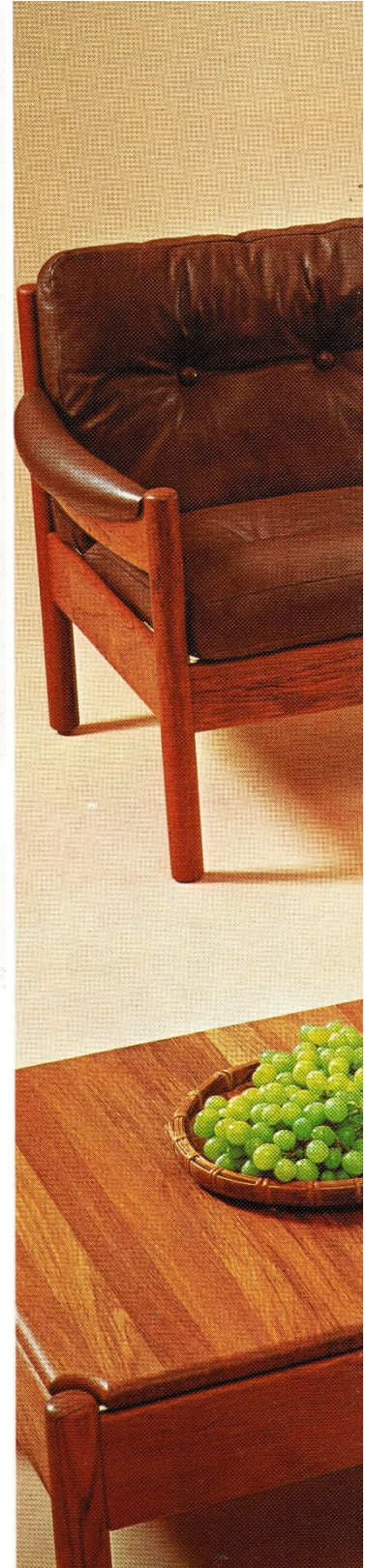

A robust and functional group offering many possibilities. The sofas have rigid frames. Armrests are interchangeable, and the cushions are loose. They can be had in leather or fabric, and the wood is teak. The coffee table is delivered knocked-down.

ML 520

ILLUM WIKKELSØ

126

FACTS:

Dining table and chair

Made by
N.Ejlersen. Denmark
1967

Mobilia nr. 138-143, Forår 1967

At the top, left: Diningtable and chair
dan. kr. 425.- and dan. kr. 238.-. De-
sign Illum Wikkelsø for N.Ejlersen
A/S. Skamby.

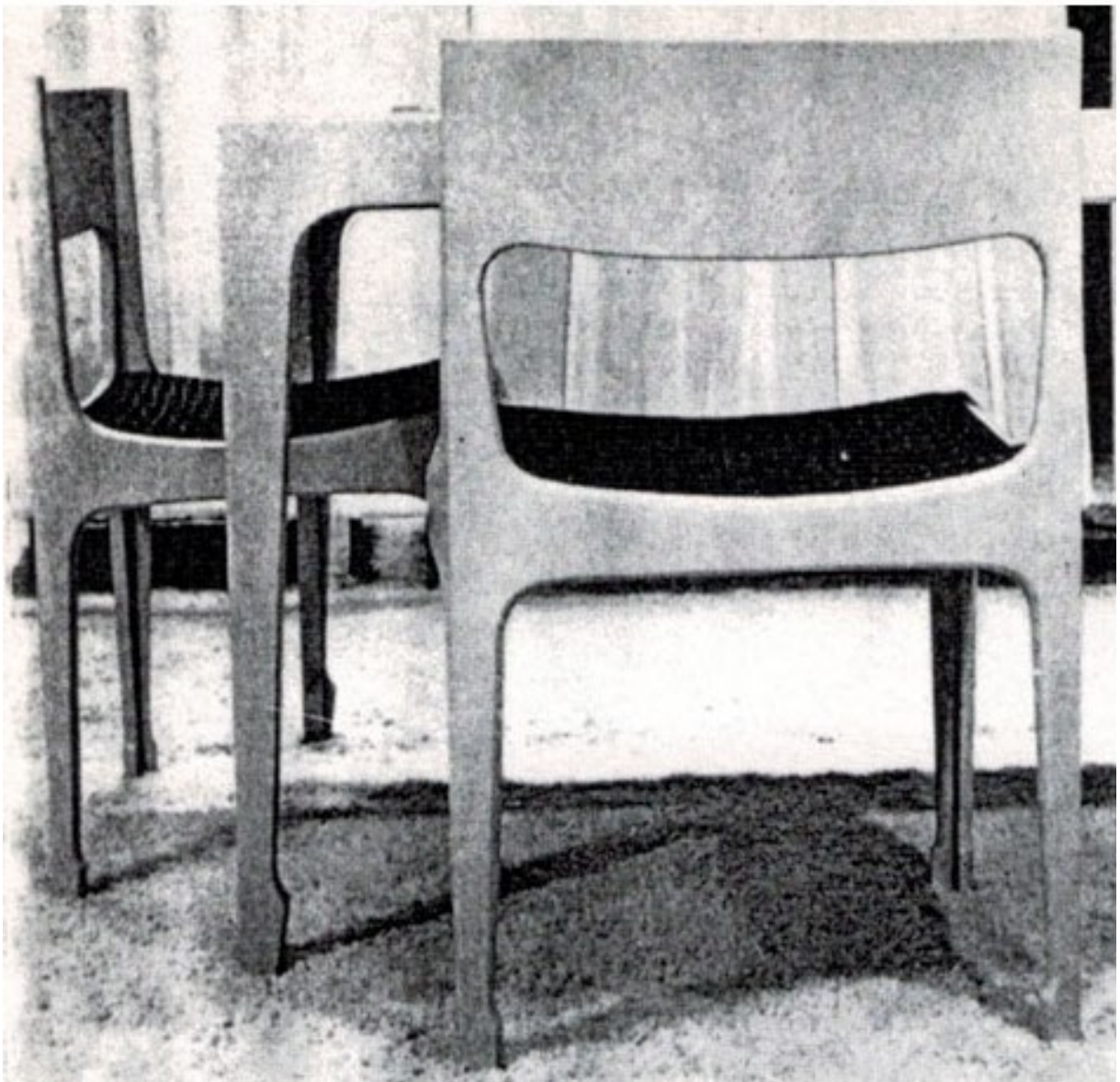

ILLUM WIKKELSØ

127

FACTS:

Furniture group
Made by
N. Ejlersen. Denmark

Pieces of beechwood of uniform size and thickness were used for these seating units. Polyether cushions with corduroy covers to complete the job. Design: Illum Wikkelsø. Made by N. Ejlersen A/S, Skamby, Denmark.

Mobilia nr. 167 - 168. Juni - Juli 1969

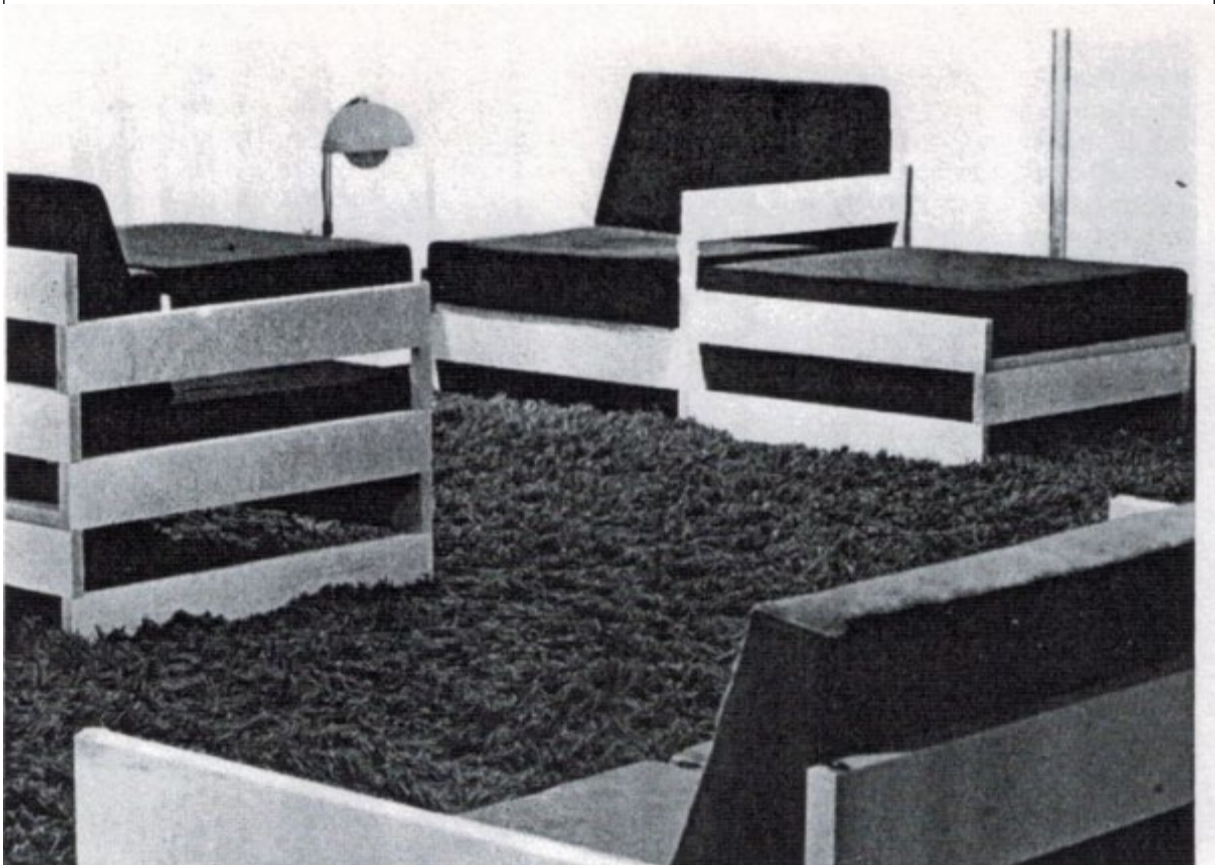

ILLUM WIKKELSØ

128

FACTS:

High back chairs

Made by
Søren Willadsens eftf.
Denmark

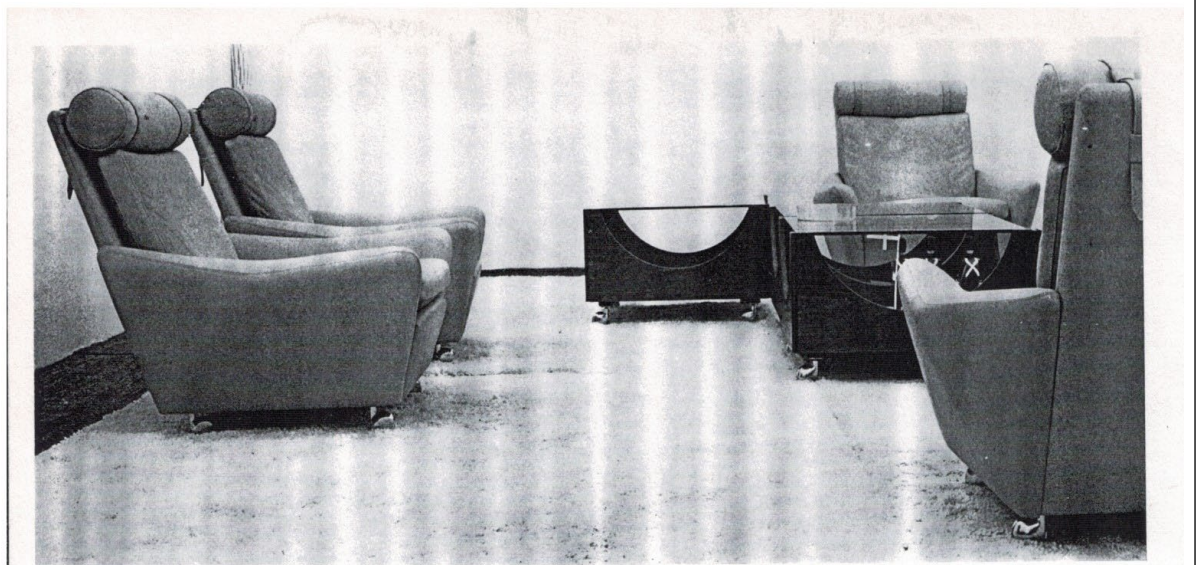

Nye polstermøbler fra Søren Willadsens Eftf.,
Vejen, tegnede af Illum Wikkelsøe.
Nye upholstered furniture from Søren Willadsens
Vejen, Denmark, designed by Illum Wikkelsøe.

Mobilia nr. 151, Februar 1968

ILLUM WIKKELSØ

129

FACTS:

Easy chair no.6 with sofa, high back chair and coffee table no. 50.

Made by
Søren Villadsen. Denmark



Published in "Bygge og Bo" Sommer 1959.



ILLUM WIKKELSØ

130

FACTS:

Chair no. 70
1959.

Made by
Søren Villadsen.
Denmark



44

Bygge og Bo, 25. årgang. Sommer 1959, Hefte 2

ILLUM WIKKELSØ

131

Facts:

High back chair

Made by

Mikael Laursen



ILLUM WIKKELSØ

132

FACTS:

The chair is made by:
P.Schultz & Co in Galten



COMMENTS

Made in steel and alumina.
Made as conference and office chair in 1970-75.



ILLUM WIKKELSØ

133

FACTS:

Box shaped lounge chair, patinate pine.

Manufactured by N. Eilersen, Skamby approximately 1969.



216

216

ILLUM WIKKELSØ

n. 1919, G. 1999

Box shaped, patinated pine lounge chair. Loose cushions in seat and back upholstered with sand coloured canvas. This example manufactured 1970s by N. Ejlersen.

Literature: "Mobilia" no. 167-168, June-July 1969.

DKK 15,000-18,000 / € 2,000-2,400

ILLUM WIKKELSØ

134

FACTS:

Sofa/
Day bed

Made by
N. Eilersen



ILLUM WIKKELSØ

135

FACTS:

Daybed:

Made by
N. Eilersen

